

Chapter 8

Gravimetric Methods

Chapter Overview

- 8A Overview of Gravimetric Methods
- 8B Precipitation Gravimetry
- 8C Volatilization Gravimetry
- 8D Particulate Gravimetry
- 8E Key Terms
- 8F Chapter Summary
- 8G Problems
- 8H Solutions to Practice Exercises

Gravimetry includes all analytical methods in which the analytical signal is a measurement of mass or a change in mass. When you step on a scale after exercising you are, in a sense, making a gravimetric determination of your mass. Mass is the most fundamental of all analytical measurements and gravimetry unquestionably is the oldest quantitative analytical technique. Vannoccio Biringuccio's *Pirotechnia*, first published in 1540, is an early example of applying gravimetry—although not yet known by this name—to the analysis of metals and ores; the first chapter of Book Three, for example, is entitled “The Method of Assaying the Ores of all Metals in General and in Particular Those That Contain Silver and Gold.”¹ Although gravimetry no longer is the most important analytical method, it continues to find use in specialized applications.

1 Smith, C. S.; Gnodi, M. T. translation of Biringuccio, V. *Pirotechnia*, MIT Press: Cambridge, MA, 1959.

8A Overview of Gravimetric Methods

Before we consider specific gravimetric methods, let's take a moment to develop a broad survey of **GRAVIMETRY**. Later, as you read through the descriptions of specific gravimetric methods, this survey will help you focus on their similarities instead of their differences. It is easier to understand a new analytical method when you can see its relationship to other similar methods.

8A.1 Using Mass as an Analytical Signal

Suppose we are to determine the total suspended solids in the water released by a sewage-treatment facility. Suspended solids are just that: solid matter that has yet to settle out of its solution matrix. The analysis is easy. After collecting a sample, we pass it through a preweighed filter that retains the suspended solids, and then dry the filter and solids to remove any residual moisture. The mass of suspended solids is the difference between the filter's final mass and its original mass. We call this a **DIRECT ANALYSIS** because the analyte—the suspended solids in this example—is the species that is weighed.

What if our analyte is an aqueous ion, such as Pb^{2+} ? Because the analyte is not a solid, we cannot isolate it by filtration. We can still measure the analyte's mass directly if we first convert it into a solid form. If we suspend a pair of Pt electrodes in the sample and apply a sufficiently positive potential between them for a long enough time, we can convert the Pb^{2+} to PbO_2 , which deposits on the Pt anode.



If we weigh the anode before and after we apply the potential, its change in mass gives the mass of PbO_2 and, from the reaction's stoichiometry, the amount of Pb^{2+} in the sample. This is a direct analysis because PbO_2 contains the analyte.

Sometimes it is easier to remove the analyte and let a change in mass serve as the analytical signal. Suppose we need to determine a food's moisture content. One approach is to heat a sample of the food to a temperature that will vaporize water and capture the water vapor using a preweighed absorbent trap. The change in the absorbent's mass provides a direct determination of the amount of water in the sample. An easier approach is to weigh the sample of food before and after we heat it and use the change in its mass to determine the amount of water originally present. We call this an **INDIRECT ANALYSIS** because we determine the analyte, H_2O in this case, using a signal that is proportional its disappearance.

The indirect determination of a sample's moisture content is made by measuring a change in mass. The sample's initial mass includes the water, but its final mass does not. We can also determine an analyte indirectly

Method 2540D in *Standard Methods for the Examination of Waters and Wastewaters*, 20th Edition (American Public Health Association, 1998) provides an approved method for determining total suspended solids. The method uses a glass-fiber filter to retain the suspended solids. After filtering the sample, the filter is dried to a constant weight at 103–105°C.

Method 925.10 in *Official Methods of Analysis*, 18th Edition (AOAC International, 2007) provides an approved method for determining the moisture content of flour. A preweighed sample is heated for one hour in a 130°C oven and transferred to a desiccator while it cools to room temperature. The loss in mass gives the amount of water in the sample.

without its being weighed. For example, phosphite, PO_3^{3-} , reduces Hg^{2+} to Hg_2^{2+} , which in the presence of Cl^- precipitates as Hg_2Cl_2 .

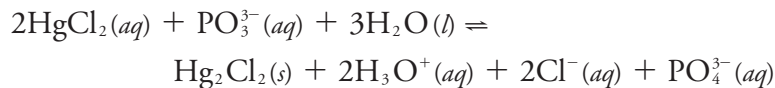

If we add HgCl_2 in excess to a sample that contains phosphite, each mole of PO_3^{3-} will produce one mole of Hg_2Cl_2 . The precipitate's mass, therefore, provides an indirect measurement of the amount of PO_3^{3-} in the original sample.

8A.2 Types of Gravimetric Methods

The examples in the previous section illustrate four different ways in which a measurement of mass may serve as an analytical signal. When the signal is the mass of a precipitate, we call the method **PRECIPITATION GRAVIMETRY**. The indirect determination of PO_3^{3-} by precipitating Hg_2Cl_2 is an example, as is the direct determination of Cl^- by precipitating AgCl .

In **ELECTROGRAVIMETRY**, we deposit the analyte as a solid film on an electrode in an electrochemical cell. The deposition as PbO_2 at a Pt anode is one example of electrogravimetry. The reduction of Cu^{2+} to Cu at a Pt cathode is another example of electrogravimetry.

When we use thermal or chemical energy to remove a volatile species, we call the method **VOLATILIZATION GRAVIMETRY**. In determining the moisture content of bread, for example, we use thermal energy to vaporize the water in the sample. To determine the amount of carbon in an organic compound, we use the chemical energy of combustion to convert it to CO_2 .

Finally, in **PARTICULATE GRAVIMETRY** we determine the analyte by separating it from the sample's matrix using a filtration or an extraction. The determination of total suspended solids is one example of particulate gravimetry.

8A.3 Conservation of Mass

An accurate gravimetric analysis requires that the analytical signal—whether it is a mass or a change in mass—is proportional to the amount of analyte in our sample. For all gravimetric methods this proportionality involves a **CONSERVATION OF MASS**. If the method relies on one or more chemical reactions, then we must know the stoichiometry of the reactions. In the analysis of PO_3^{3-} described earlier, for example, we know that each mole of Hg_2Cl_2 corresponds to a mole of PO_3^{3-} . If we remove the analyte from its matrix, then the separation must be selective for the analyte. When determining the moisture content in bread, for example, we know that the mass of H_2O in the bread is the difference between the sample's final mass and its initial mass.

We will not consider electrogravimetry in this chapter. See Chapter 11 on electrochemical methods of analysis for a further discussion of electrogravimetry.

We will return to this concept of applying a conservation of mass later in the chapter when we consider specific examples of gravimetric methods.

Other examples of definitive techniques are coulometry and isotope-dilution mass spectrometry. Coulometry is discussed in Chapter 11. Isotope-dilution mass spectrometry is beyond the scope of this textbook; however, you will find some suggested readings in this chapter's Additional Resources.

Most precipitation gravimetric methods were developed in the nineteenth century, or earlier, often for the analysis of ores. [Figure 1.1](#) in Chapter 1, for example, illustrates a precipitation gravimetric method for the analysis of nickel in ores.

A total analysis technique is one in which the analytical signal—mass in this case—is proportional to the absolute amount of analyte in the sample. See Chapter 3 for a discussion of the difference between total analysis techniques and concentration techniques.

8A.4 Why Gravimetry is Important

Except for particulate gravimetry, which is the most trivial form of gravimetry, you probably will not use gravimetry after you complete this course. Why, then, is familiarity with gravimetry still important? The answer is that gravimetry is one of only a small number of **DEFINITIVE TECHNIQUES** whose measurements require only base SI units, such as mass or the mole, and defined constants, such as Avogadro's number and the mass of ^{12}C . Ultimately, we must be able to trace the result of any analysis to a definitive technique, such as gravimetry, that we can relate to fundamental physical properties.² Although most analysts never use gravimetry to validate their results, they often verify an analytical method by analyzing a standard reference material whose composition is traceable to a definitive technique.³

8B Precipitation Gravimetry

In precipitation gravimetry an insoluble compound forms when we add a precipitating reagent, or **PRECIPITANT**, to a solution that contains our analyte. In most cases the precipitate is the product of a simple metathesis reaction between the analyte and the precipitant; however, any reaction that generates a precipitate potentially can serve as a gravimetric method.

8B.1 Theory and Practice

All precipitation gravimetric analyses share two important attributes. First, the precipitate must be of low solubility, of high purity, and of known composition if its mass is to reflect accurately the analyte's mass. Second, it must be easy to separate the precipitate from the reaction mixture.

SOLUBILITY CONSIDERATIONS

To provide an accurate result, a precipitate's solubility must be minimal. The accuracy of a total analysis technique typically is better than $\pm 0.1\%$, which means the precipitate must account for at least 99.9% of the analyte. Extending this requirement to 99.99% ensures the precipitate's solubility will not limit the accuracy of a gravimetric analysis.

We can minimize solubility losses by controlling the conditions under which the precipitate forms. This, in turn, requires that we account for every equilibrium reaction that might affect the precipitate's solubility. For example, we can determine Ag^+ gravimetrically by adding NaCl as a precipitant, forming a precipitate of AgCl .



If this is the only reaction we consider, then we predict that the precipitate's solubility, S_{AgCl} , is given by the following equation.

² Valacárcel, M.; Ríos, A. *Analyst* **1995**, *120*, 2291–2297.

³ (a) Moody, J. R.; Epstein, M. S. *Spectrochim. Acta* **1991**, *46B*, 1571–1575; (b) Epstein, M. S. *Spectrochim. Acta* **1991**, *46B*, 1583–1591.

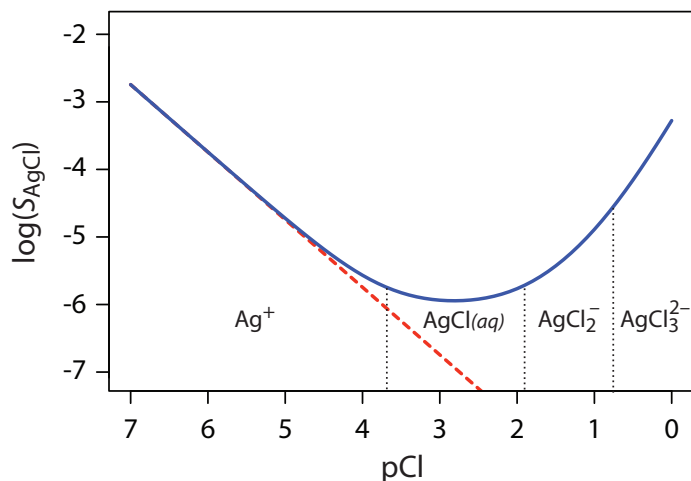
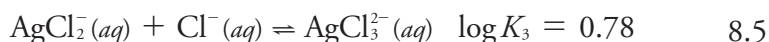
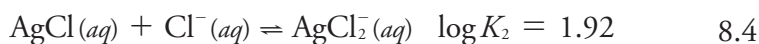
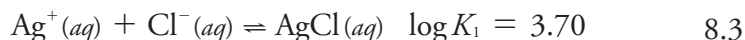

Figure 8.1 Solubility of AgCl as a function of pCl. The dashed red line shows our prediction for S_{AgCl} if we assume incorrectly that only [reaction 8.1](#) and equation 8.2 affect silver chloride's solubility. The solid blue curve is calculated using equation 8.7, which accounts for [reaction 8.1](#) and reactions 8.3–8.5. Because the solubility of AgCl spans several orders of magnitude, S_{AgCl} is displayed on the y -axis in logarithmic form. The vertical dotted lines are a ladder diagram for the silver-chloro complexes.

$$S_{\text{AgCl}} = [\text{Ag}^+] = \frac{K_{\text{sp}}}{[\text{Cl}^-]} \quad 8.2$$

Equation 8.2 suggests that we can minimize solubility losses by adding a large excess of Cl^- . In fact, as shown in Figure 8.1, adding a large excess of Cl^- increases the precipitate's solubility.

To understand why the solubility of AgCl is more complicated than the relationship suggested by equation 8.2, we must recall that Ag^+ also forms a series of soluble silver-chloro metal–ligand complexes.



The actual solubility of AgCl is the sum of the equilibrium concentrations for all soluble forms of Ag^+ .

$$S_{\text{AgCl}} = [\text{Ag}^+] + [\text{AgCl}(aq)] + [\text{AgCl}_2^-] + [\text{AgCl}_3^{2-}] \quad 8.6$$

By substituting into equation 8.6 the equilibrium constant expressions for [reaction 8.1](#) and reactions 8.3–8.5, we can define the solubility of AgCl as

$$S_{\text{AgCl}} = \frac{K_{\text{sp}}}{[\text{Cl}^-]} + K_1 K_{\text{sp}} + K_1 K_2 K_{\text{sp}} [\text{Cl}^-] + K_1 K_2 K_3 K_{\text{sp}} [\text{Cl}^-]^2 \quad 8.7$$

Equation 8.7 explains the solubility curve for AgCl shown in Figure 8.1. As we add NaCl to a solution of Ag^+ , the solubility of AgCl initially decreases because of [reaction 8.1](#). Under these conditions, the final three terms in equation 8.7 are small and [equation 8.2](#) is sufficient to describe AgCl's solubility. For higher concentrations of Cl^- , reaction 8.4 and reaction 8.5 increase the solubility of AgCl. Clearly the equilibrium concentration of

Note the difference between reaction 8.3, in which we form $\text{AgCl}(aq)$ as a product, and [reaction 8.1](#), in which we form $\text{AgCl}(s)$ as a product. The formation of $\text{AgCl}(aq)$ from $\text{AgCl}(s)$

$\text{AgCl}(s) = \text{AgCl}(aq)$
is called AgCl's intrinsic solubility.

[Problem 1](#) in the end-of-chapter problems asks you to show that equation 8.7 is correct by completing its derivation.

The predominate silver-chloro complexes for different values of pCl are shown by the ladder diagram along the x -axis in [Figure 8.1](#). Note that the increase in solubility begins when the higher-order soluble complexes of $AgCl_2^-$ and $AgCl_3^{2-}$ are the predominate species.

Be sure that equation 8.10 makes sense to you. Reaction 8.8 tells us that the dissolution of CaF_2 produces one mole of Ca^{2+} for every two moles of F^- , which explains the term of $1/2$ in equation 8.10. Because F^- is a weak base, we must account for both chemical forms in solution, which explains why we include HF.

[Problem 4](#) in the end-of-chapter problems asks you to show that equation 8.11 is correct by completing the derivation.

chloride is important if we wish to determine the concentration of silver by precipitating $AgCl$. In particular, we must avoid a large excess of chloride.

Another important parameter that may affect a precipitate's solubility is pH. For example, a hydroxide precipitate, such as $Fe(OH)_3$, is more soluble at lower pH levels where the concentration of OH^- is small. Because fluoride is a weak base, the solubility of calcium fluoride, S_{CaF_2} , also is pH-dependent. We can derive an equation for S_{CaF_2} by considering the following equilibrium reactions

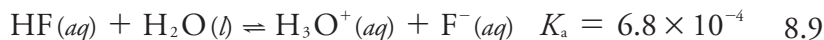
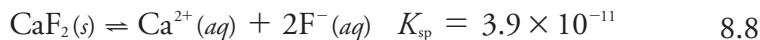

and the following equation for the solubility of CaF_2 .

$$S_{CaF_2} = [Ca^{2+}] = \frac{1}{2}\{[F^-] + [HF]\} \quad 8.10$$

Substituting the equilibrium constant expressions for reaction 8.8 and reaction 8.9 into equation 8.10 allows us to define the solubility of CaF_2 in terms of the equilibrium concentration of H_3O^+ .

$$S_{CaF_2} = [Ca^{2+}] = \left\{ \frac{K_{sp}}{4} \left(1 + \frac{[H_3O^+]}{K_a} \right)^2 \right\}^{1/3} \quad 8.11$$

Figure 8.2 shows how pH affects the solubility of CaF_2 . Depending on the solution's pH, the predominate form of fluoride is either HF or F^- . When the pH is greater than 4.17, the predominate species is F^- and the solubility of CaF_2 is independent of pH because only reaction 8.8 occurs to an appreciable extent. At more acidic pH levels, the solubility of CaF_2 increases because of the contribution of reaction 8.9.

When solubility is a concern, it may be possible to decrease solubility by using a non-aqueous solvent. A precipitate's solubility generally is greater in an aqueous solution because of water's ability to stabilize ions through solvation. The poorer solvating ability of a non-aqueous solvent, even those that are polar, leads to a smaller solubility product. For example, the K_{sp}

Figure 8.2 Solubility of CaF_2 as a function of pH. The solid blue curve is a plot of equation 8.11. The predominate form of fluoride in solution is shown by the ladder diagram along the x -axis, with the **black** rectangle indicating the region where both HF and F^- are important species. Note that the solubility of CaF_2 is independent of pH for pH levels greater than 4.17, and that its solubility increases dramatically at lower pH levels where HF is the predominate species. Because the solubility of CaF_2 spans several orders of magnitude, its solubility is shown in logarithmic form.

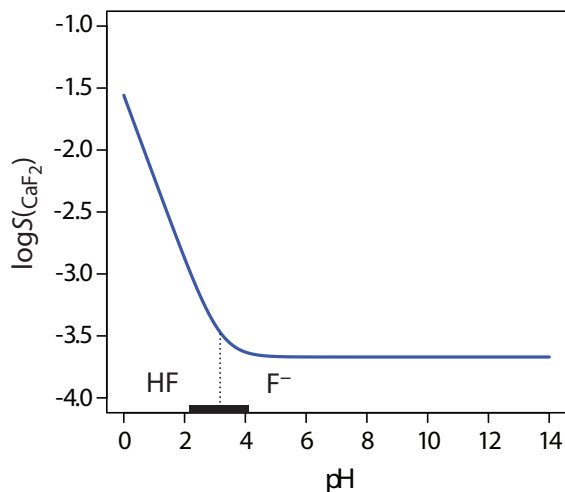

of PbSO_4 is 2×10^{-8} in H_2O and 2.6×10^{-12} in a 50:50 mixture of H_2O and ethanol.

AVOIDING IMPURITIES

In addition to having a low solubility, a precipitate must be free from impurities. Because precipitation usually occurs in a solution that is rich in dissolved solids, the initial precipitate often is impure. To avoid a determinate error, we must remove these impurities before we determine the precipitate's mass.

The greatest source of impurities are chemical and physical interactions that take place at the precipitate's surface. A precipitate generally is crystalline—even if only on a microscopic scale—with a well-defined lattice of cations and anions. Those cations and anions at the precipitate's surface carry, respectively, a positive or a negative charge because they have incomplete coordination spheres. In a precipitate of AgCl , for example, each silver ion in the precipitate's interior is bound to six chloride ions. A silver ion at the surface, however, is bound to no more than five chloride ions and carries a partial positive charge (Figure 8.3). The presence of these partial charges makes the precipitate's surface an active site for the chemical and physical interactions that produce impurities.

One common impurity is an **INCLUSION**, in which a potential interferent, whose size and charge is similar to a lattice ion, can substitute into the lattice structure if the interferent precipitates with the same crystal structure (Figure 8.4a). The probability of forming an inclusion is greatest when the interfering ion's concentration is substantially greater than the lattice ion's concentration. An inclusion does not decrease the amount of analyte that

Practice Exercise 8.1

You can use a ladder diagram to predict the conditions that will minimize a precipitate's solubility. Draw a ladder diagram for oxalic acid, $\text{H}_2\text{C}_2\text{O}_4$, and use it to predict the range of pH values that will minimize the solubility of CaC_2O_4 . Relevant equilibrium constants are in the appendices.

Click [here](#) to review your answer to this exercise.

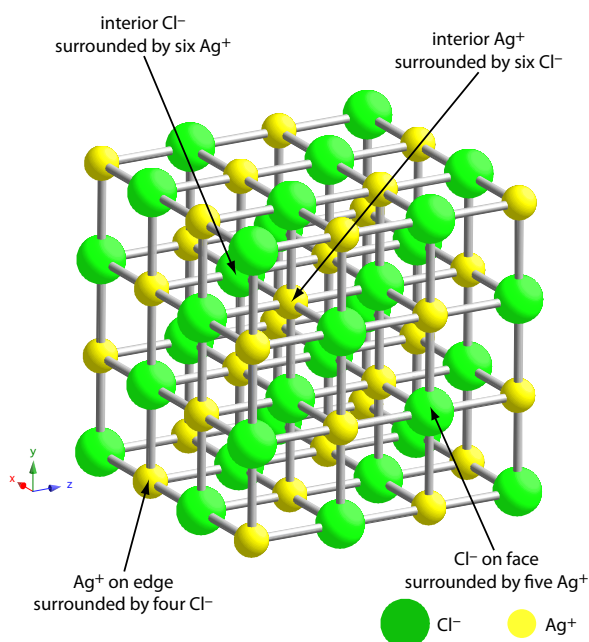

Figure 8.3 Ball-and-stick model showing the lattice structure of AgCl . Each silver ion in the lattice's interior binds with six chloride ions and each chloride ion in the interior binds with six silver ions. Those ions on the lattice's surface or edges bind to fewer than six ions and carry a partial charge. A silver ion on the surface, for example, carries a partial positive charge. These charges make a precipitate's surface an active site for chemical and physical interactions.

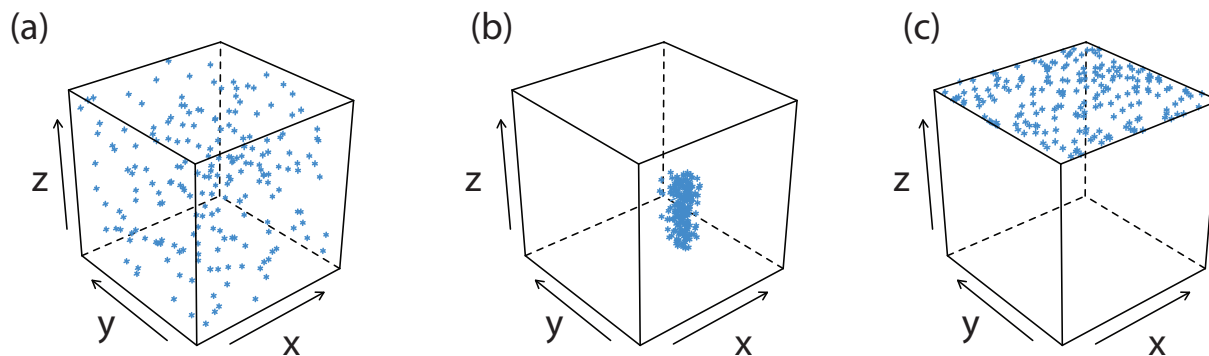

Figure 8.4 Three examples of impurities that may form during precipitation. The cubic frame represents the precipitate and the **blue** marks are impurities present as (a) inclusions, (b) oclusions, and (c) surface adsorbates. Inclusions are randomly distributed throughout the precipitate. Oclusions are localized within the interior of the precipitate and surface adsorbates are localized on the precipitate's exterior. For ease of viewing, in (c) adsorption is shown on only one surface.

Suppose that 10% of an interferent forms an inclusion during each precipitation. When we initially form the precipitate, 10% of the original interferent is present as an inclusion. After the first reprecipitation, 10% of the included interferent remains, which is 1% of the original interferent. A second reprecipitation decreases the interferent to 0.1% of the original amount.

precipitates, provided that the precipitant is present in sufficient excess. Thus, the precipitate's mass always is larger than expected.

An inclusion is difficult to remove since it is chemically part of the precipitate's lattice. The only way to remove an inclusion is through **REPRECIPITATION** in which we isolate the precipitate from its supernatant solution, dissolve the precipitate by heating in a small portion of a suitable solvent, and then reform the precipitate by allowing the solution to cool. Because the interferent's concentration after dissolving the precipitate is less than that in the original solution, the amount of included material decreases upon reprecipitation. We can repeat the process of reprecipitation until the inclusion's mass is insignificant. The loss of analyte during reprecipitation, however, is a potential source of determinate error.

AN **OCLUSION** forms when an interfering ions is trapped within the growing precipitate. Unlike an inclusion, which is randomly dispersed within the precipitate, an oclusion is localized, either along flaws within the precipitate's lattice structure or within aggregates of individual precipitate particles (Figure 8.4b). An oclusion usually increases a precipitate's mass; however, the precipitate's mass is smaller if the oclusion includes the analyte in a lower molecular weight form than that of the precipitate.

We can minimize an oclusion by maintaining the precipitate in equilibrium with its supernatant solution for an extended time, a process called **DIGESTION**. During a digestion, the dynamic nature of the solubility–precipitation equilibria, in which the precipitate dissolves and reforms, ensures that the oclusion eventually is reexposed to the supernatant solution. Because the rates of dissolution and reprecipitation are slow, there is less opportunity for forming new oclusions.

After precipitation is complete the surface continues to attract ions from solution (Figure 8.4c). These **SURFACE ADSORBATES** comprise a third type of impurity. We can minimize surface adsorption by decreasing the

precipitate's available surface area. One benefit of digestion is that it increases a precipitate's average particle size. Because the probability that a particle will dissolve completely is inversely proportional to its size, during digestion larger particles increase in size at the expense of smaller particles. One consequence of forming a smaller number of larger particles is an overall decrease in the precipitate's surface area. We also can remove surface adsorbates by washing the precipitate, although we cannot ignore the potential loss of analyte.

Inclusions, occlusions, and surface adsorbates are examples of **COPRECIPITATES**—otherwise soluble species that form along with the precipitate that contains the analyte. Another type of impurity is an interferent that forms an independent precipitate under the conditions of the analysis. For example, the precipitation of nickel dimethylglyoxime requires a slightly basic pH. Under these conditions any Fe^{3+} in the sample will precipitate as $\text{Fe}(\text{OH})_3$. In addition, because most precipitants rarely are selective toward a single analyte, there is a risk that the precipitant will react with both the analyte and an interferent.

We can minimize the formation of additional precipitates by controlling solution conditions. If an interferent forms a precipitate that is less soluble than the analyte's precipitate, we can precipitate the interferent and remove it by filtration, leaving the analyte behind in solution. Alternatively, we can mask the analyte or the interferent to prevent its precipitation.

Both of the approaches outline above are illustrated in Fresenius' analytical method for the determination of Ni in ores that contain Pb^{2+} , Cu^{2+} , and Fe^{3+} (see [Figure 1.1](#) in Chapter 1). Dissolving the ore in the presence of H_2SO_4 selectively precipitates Pb^{2+} as PbSO_4 . Treating the resulting supernatant with H_2S precipitates Cu^{2+} as CuS . After removing the CuS by filtration, ammonia is added to precipitate Fe^{3+} as $\text{Fe}(\text{OH})_3$. Nickel, which forms a soluble amine complex, remains in solution.

CONTROLLING PARTICLE SIZE

Size matters when it comes to forming a precipitate. Larger particles are easier to filter and, as noted earlier, a smaller surface area means there is less opportunity for surface adsorbates to form. By controlling the reaction conditions we can significantly increase a precipitate's average particle size.

The formation of a precipitate consists of two distinct events: nucleation, the initial formation of smaller, stable particles of the precipitate, and particle growth. Larger particles form when the rate of particle growth exceeds the rate of nucleation. Understanding the conditions that favor particle growth is important when we design a gravimetric method of analysis.

We define a solute's **RELATIVE SUPERSATURATION**, RSS , as

$$RSS = \frac{Q - S}{S} \quad 8.12$$

In addition to forming a precipitate with Ni^{2+} , dimethylglyoxime also forms precipitates with Pd^{2+} and Pt^{2+} . These cations are potential interferents in an analysis for nickel.

Masking was introduced in Chapter 7.

A supersaturated solution is one that contains more dissolved solute than that predicted by equilibrium chemistry. A supersaturated solution is inherently unstable and precipitates solute to reach its equilibrium position. How quickly precipitation occurs depends, in part, on the value of RSS .

where Q is the solute's actual concentration and S is the solute's concentration at equilibrium.⁴ The numerator of [equation 8.12](#), $Q - S$, is a measure of the solute's supersaturation. A solution with a large, positive value of RSS has a high rate of nucleation and produces a precipitate with many small particles. When the RSS is small, precipitation is more likely to occur by particle growth than by nucleation.

[Equation 8.12](#) suggests that we can minimize RSS if we decrease the solute's concentration, Q , or if we increase the precipitate's solubility, S . A precipitate's solubility usually increases at higher temperatures and adjusting pH may affect a precipitate's solubility if it contains an acidic or a basic ion. Temperature and pH, therefore, are useful ways to increase the value of S . Forming the precipitate in a dilute solution of analyte or adding the precipitant slowly and with vigorous stirring are ways to decrease the value of Q .

There are practical limits to minimizing RSS . Some precipitates, such as $\text{Fe}(\text{OH})_3$ and PbS , are so insoluble that S is very small and a large RSS is unavoidable. Such solutes inevitably form small particles. In addition, conditions that favor a small RSS may lead to a relatively stable supersaturated solution that requires a long time to precipitate fully. For example, almost a month is required to form a visible precipitate of BaSO_4 under conditions in which the initial RSS is 5.⁵

A visible precipitate takes longer to form when RSS is small both because there is a slow rate of nucleation and because there is a steady decrease in RSS as the precipitate forms. One solution to the latter problem is to generate the precipitant *in situ* as the product of a slow chemical reaction, which effectively maintains a constant RSS . Because the precipitate forms under conditions of low RSS , initial nucleation produces a small number of particles. As additional precipitant forms, particle growth supersedes nucleation, which results in larger particles of precipitate. This process is called a **HOMOGENEOUS PRECIPITATION**.⁶

Two general methods are used for homogeneous precipitation. If the precipitate's solubility is pH-dependent, then we can mix the analyte and the precipitant under conditions where precipitation does not occur, and then increase or decrease the pH by chemically generating OH^- or H_3O^+ . For example, the hydrolysis of urea, $\text{CO}(\text{NH}_2)_2$, is a source of OH^- because of the following two reactions.

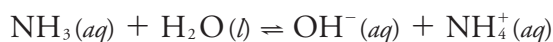
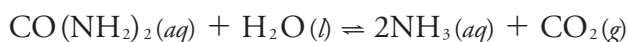

Because the hydrolysis of urea is temperature-dependent—the rate is negligible at room temperature—we can use temperature to control the rate of

4 Von Weimarn, P. P. *Chem. Revs.* **1925**, 2, 217–242.

5 Bassett, J.; Denney, R. C.; Jeffery, G. H. Mendham, J. *Vogel's Textbook of Quantitative Inorganic Analysis*, Longman: London, 4th Ed., 1981, p. 408.

6 Gordon, L.; Salutsky, M. L.; Willard, H. H. *Precipitation from Homogeneous Solution*, Wiley: NY, 1959.

hydrolysis and the rate of precipitate formation. Precipitates of CaC_2O_4 , for example, have been produced by this method. After dissolving a sample that contains Ca^{2+} , the solution is made acidic with HCl before adding a solution of 5% w/v $(\text{NH}_4)_2\text{C}_2\text{O}_4$. Because the solution is acidic, a precipitate of CaC_2O_4 does not form. The solution is heated to approximately 50°C and urea is added. After several minutes, a precipitate of CaC_2O_4 begins to form, with precipitation reaching completion in about 30 min.

In the second method of homogeneous precipitation, the precipitant is generated by a chemical reaction. For example, Pb^{2+} is precipitated homogeneously as PbCrO_4 by using bromate, BrO_3^- , to oxidize Cr^{3+} to CrO_4^{2-} .

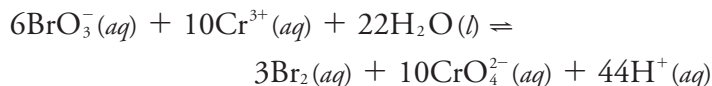

Figure 8.5 shows the result of preparing PbCrO_4 by direct addition of KCrO_4 (Beaker A) and by homogeneous precipitation (Beaker B). Both beakers contain the same amount of PbCrO_4 . Because the direct addition of KCrO_4 leads to rapid precipitation and the formation of smaller particles, the precipitate remains less settled than the precipitate prepared homogeneously. Note, as well, the difference in the color of the two precipitates.

A homogeneous precipitation produces large particles of precipitate that are relatively free from impurities. These advantages, however, are offset by the increased time needed to produce the precipitate and by a tendency for the precipitate to deposit as a thin film on the container's walls. The latter problem is particularly severe for hydroxide precipitates generated using urea.

An additional method for increasing particle size deserves mention. When a precipitate's particles are electrically neutral they tend to coagulate into larger particles that are easier to filter. Surface adsorption of excess lattice ions, however, provides the precipitate's particles with a net positive or a net negative surface charge. Electrostatic repulsion between particles of similar charge prevents them from coagulating into larger particles.

Let's use the precipitation of AgCl from a solution of AgNO_3 using NaCl as a precipitant to illustrate this effect. Early in the precipitation,

The effect of particle size on color is well-known to geologists, who use a streak test to help identify minerals. The color of a bulk mineral and its color when powdered often are different. Rubbing a mineral across an unglazed porcelain plate leaves behind a small streak of the powdered mineral. Bulk samples of hematite, Fe_2O_3 , are black in color, but its streak is a familiar rust-red. Crocite, the mineral PbCrO_4 , is red-orange in color; its streak is orange-yellow.

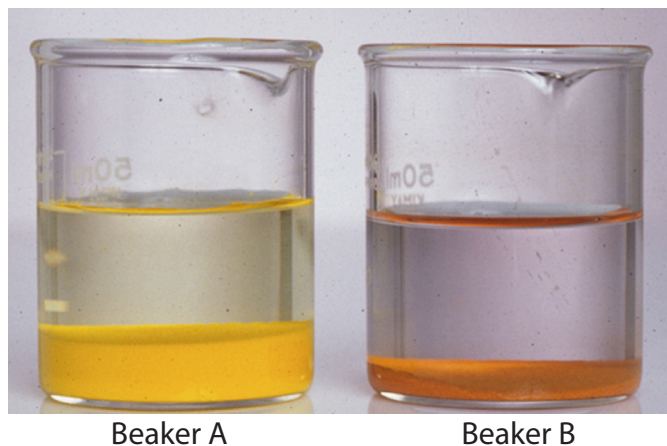

Figure 8.5 Two precipitates of PbCrO_4 . In Beaker A, mixing together 0.1 M $\text{Pb}(\text{NO}_3)_2$ and 0.1 M K_2CrO_4 forms the precipitate under conditions of high RSS. The precipitate forms rapidly and consists of very small particles. In Beaker B, heating a solution of 0.1 M $\text{Pb}(\text{NO}_3)_2$, 0.1 M $\text{Cr}(\text{NO}_3)_3$, and 0.1 M KBrO_3 slowly oxidizes Cr^{3+} to CrO_4^{2-} , precipitating PbCrO_4 under conditions of low RSS. The precipitate forms slowly and consists of much larger particles.

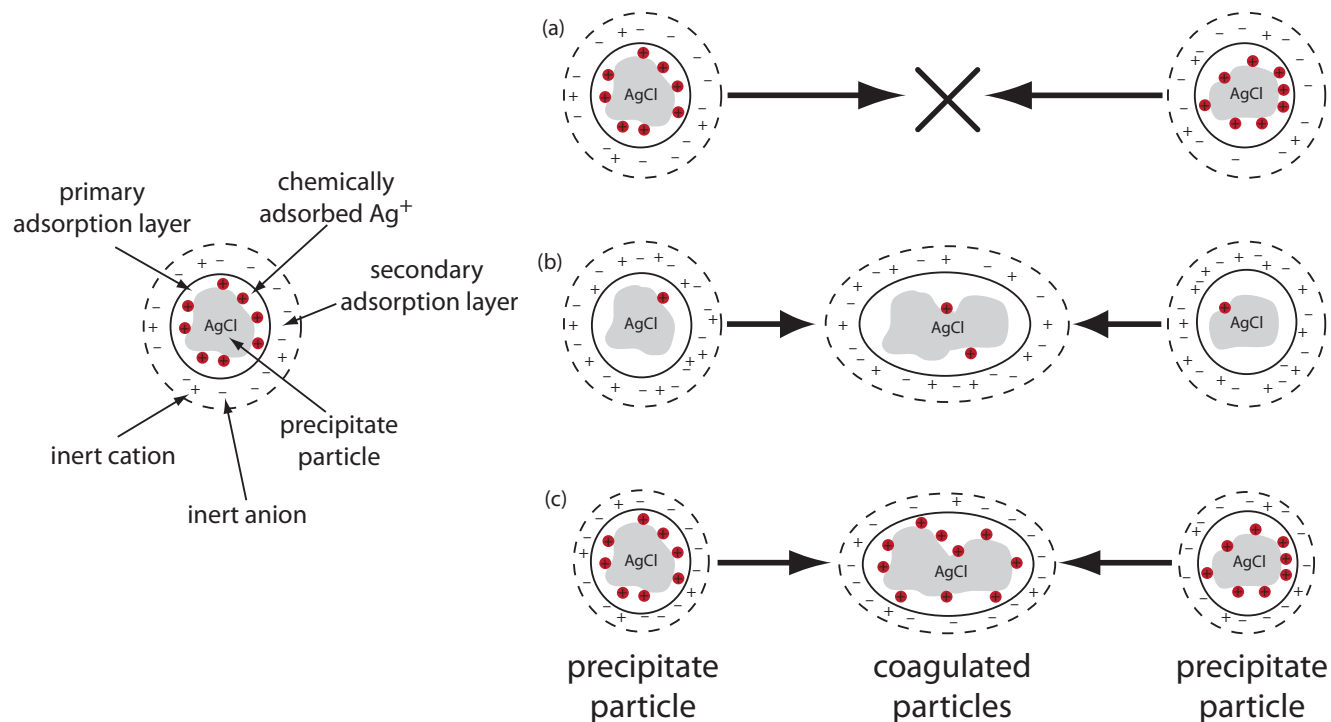

Figure 8.6 Two methods for coagulating a precipitate of AgCl. (a) Coagulation does not occur due to the electrostatic repulsion between the positively charged particles. (b) Decreasing the charge within the primary adsorption layer, by adding additional NaCl, decreases the electrostatic repulsion and allows the particles to coagulate. (c) Adding additional inert ions decreases the thickness of the secondary adsorption layer. Because the particles can approach each other more closely, they are able to coagulate.

when NaCl is the limiting reagent, excess Ag⁺ ions chemically adsorb to the AgCl particles, forming a positively charged primary adsorption layer (Figure 8.6a). The solution in contact with this layer contains more inert anions, NO₃⁻ in this case, than inert cations, Na⁺, giving a secondary adsorption layer with a negative charge that balances the primary adsorption layer's positive charge. The solution outside the secondary adsorption layer remains electrically neutral. **COAGULATION** cannot occur if the secondary adsorption layer is too thick because the individual particles of AgCl are unable to approach each other closely enough.

We can induce coagulation in three ways: by decreasing the number of chemically adsorbed Ag⁺ ions, by increasing the concentration of inert ions, or by heating the solution. As we add additional NaCl, precipitating more of the excess Ag⁺, the number of chemically adsorbed silver ions decreases and coagulation occurs (Figure 8.6b). Adding too much NaCl, however, creates a primary adsorption layer of excess Cl⁻ with a loss of coagulation.

A second way to induce coagulation is to add an inert electrolyte, which increases the concentration of ions in the secondary adsorption layer (Figure 8.6c). With more ions available, the thickness of the secondary adsorption layer decreases. Particles of precipitate may now approach each other more closely, which allows the precipitate to coagulate. The amount of

The coagulation and decoagulation of AgCl as we add NaCl to a solution of AgNO₃ can serve as an endpoint for a titration. See Chapter 9 for additional details.

electrolyte needed to cause spontaneous coagulation is called the critical coagulation concentration.

Heating the solution and the precipitate provides a third way to induce coagulation. As the temperature increases, the number of ions in the primary adsorption layer decreases, which lowers the precipitate's surface charge. In addition, heating increases the particles' kinetic energy, allowing them to overcome the electrostatic repulsion that prevents coagulation at lower temperatures.

FILTERING THE PRECIPITATE

After precipitating and digesting a precipitate, we separate it from solution by filtering. The most common filtration method uses filter paper, which is classified according to its speed, its size, and its ash content on ignition. Speed, or how quickly the supernatant passes through the filter paper, is a function of the paper's pore size. A larger pore size allows the supernatant to pass more quickly through the filter paper, but does not retain small particles of precipitate. Filter paper is rated as fast (retains particles larger than 20–25 μm), medium–fast (retains particles larger than 16 μm), medium (retains particles larger than 8 μm), and slow (retains particles larger than 2–3 μm). The proper choice of filtering speed is important. If the filtering speed is too fast, we may fail to retain some of the precipitate, which causes a negative determinate error. On the other hand, the precipitate may clog the pores if we use a filter paper that is too slow.

Because filter paper is hygroscopic, it is not easy to dry it to a constant weight. When accuracy is important, the filter paper is removed before we determine the precipitate's mass. After transferring the precipitate and filter paper to a covered crucible, we heat the crucible to a temperature that converts the paper to $\text{CO}_2(\text{g})$ and $\text{H}_2\text{O}(\text{g})$, a process called **IGNITION**.

Gravity filtration is accomplished by folding the filter paper into a cone and placing it in a long-stem funnel ([Figure 8.7](#)). To form a tight seal between the filter cone and the funnel, we dampen the paper with water or supernatant and press the paper to the wall of the funnel. When prepared properly, the funnel's stem fills with the supernatant, increasing the rate of filtration.

The precipitate is transferred to the filter in several steps. The first step is to decant the majority of the **SUPERNATANT** through the filter paper without transferring the precipitate ([Figure 8.8](#)). This prevents the filter paper from clogging at the beginning of the filtration process. The precipitate is rinsed while it remains in its beaker, with the rinsings decanted through the filter paper. Finally, the precipitate is transferred onto the filter paper using a stream of rinse solution. Any precipitate that clings to the walls of the beaker is transferred using a rubber policeman (a flexible rubber spatula attached to the end of a glass stirring rod).

An alternative method for filtering a precipitate is to use a filtering crucible. The most common option is a fritted-glass crucible that contains

A filter paper's size is just its diameter. Filter paper comes in many sizes, including 4.25 cm, 7.0 cm, 11.0 cm, 12.5 cm, 15.0 cm, and 27.0 cm. Choose a size that fits comfortably into your funnel. For a typical 65-mm long-stem funnel, 11.0 cm and 12.5 cm filter paper are good choices.

Igniting a poor quality filter paper leaves behind a residue of inorganic ash. For quantitative work, use a low-ash filter paper. This grade of filter paper is pretreated with a mixture of HCl and HF to remove inorganic materials. Quantitative filter paper typically has an ash content of less than 0.01% w/w.

Figure 8.7 To prepare a filter paper cone the filter paper circle is (a) folded in half (b), folded in half a second time (c), parted (d) and a small corner is torn off (e) before the paper is opened up into a cone and placed in the funnel (f).

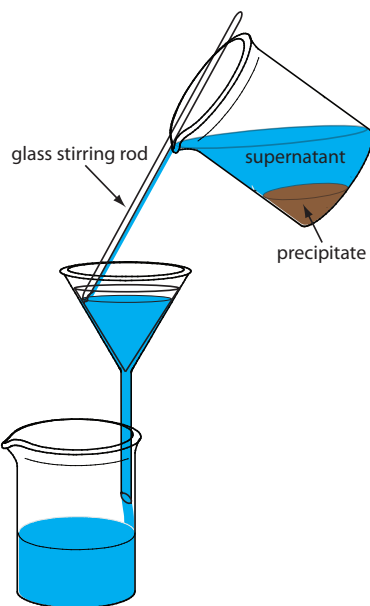
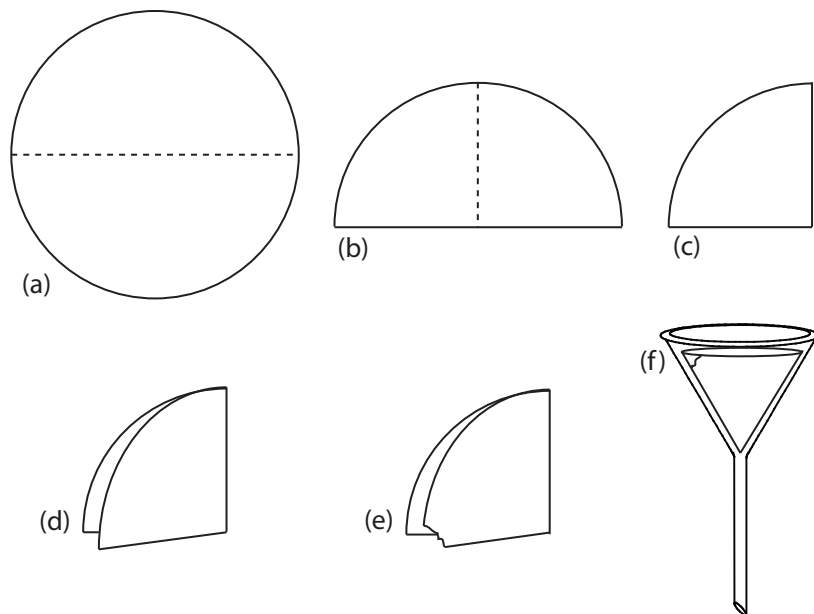

Figure 8.8 Proper procedure for transferring the supernatant to the filter paper cone. The glass stirring rod allows the supernatant to trickle into the funnel without splashing.

a porous glass disk filter. Fritted-glass crucibles are classified by their porosity: coarse (retaining particles larger than 40–60 μm), medium (retaining particles greater than 10–15 μm), and fine (retaining particles greater than 4–5.5 μm). Another type of filtering crucible is the Gooch crucible, which is a porcelain crucible with a perforated bottom. A glass fiber mat is placed in the crucible to retain the precipitate. For both types of crucibles, the precipitate is transferred in the same manner described earlier for filter paper. Instead of using gravity, the supernatant is drawn through the crucible with the assistance of suction from a vacuum aspirator or pump ([Figure 8.9](#)).

RINSING THE PRECIPITATE

Because the supernatant is rich with dissolved inert ions, we must remove residual traces of supernatant without incurring loss of analyte due to solubility. In many cases this simply involves the use of cold solvents or rinse solutions that contain organic solvents such as ethanol. The pH of the rinse solution is critical if the precipitate contains an acidic or a basic ion. When coagulation plays an important role in determining particle size, adding a volatile inert electrolyte to the rinse solution prevents the precipitate from reverting into smaller particles that might pass through the filter. This process of reverting to smaller particles is called **PEPTIZATION**. The volatile electrolyte is removed when drying the precipitate.

In general, we can minimize the loss of analyte if we use several small portions of rinse solution instead of a single large volume. Testing the used rinse solution for the presence of an impurity is another way to guard against over-rinsing the precipitate. For example, if Cl^- is a residual ion in the supernatant, we can test for its presence using AgNO_3 . After we collect a small portion of the rinse solution, we add a few drops of AgNO_3 and look for the presence or absence of a precipitate of AgCl . If a precipitate forms,

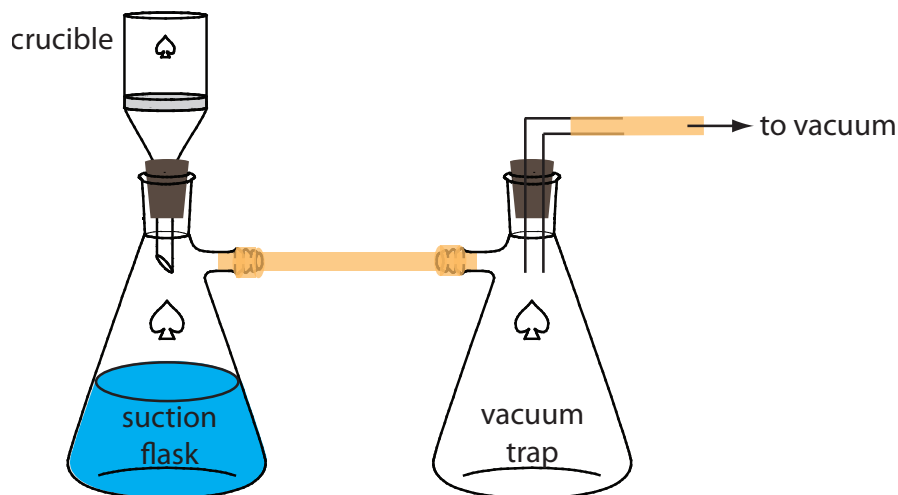

Figure 8.9 Procedure for filtering a precipitate through a filtering crucible. The trap prevents water from the aspirator from back-washing into the suction flask.

then we know Cl^- is present and continue to rinse the precipitate. Additional rinsing is not needed if the AgNO_3 does not produce a precipitate.

DRYING THE PRECIPITATE

After separating the precipitate from its supernatant solution, we dry the precipitate to remove residual traces of rinse solution and to remove any volatile impurities. The temperature and method of drying depend on the method of filtration and the precipitate's desired chemical form. Placing the precipitate in a laboratory oven and heating to a temperature of 110°C is sufficient to remove water and other easily volatilized impurities. Higher temperatures require a muffle furnace, a Bunsen burner, or a Meker burner, and are necessary if we need to decompose the precipitate before its weight is determined.

Because filter paper absorbs moisture, we must remove it before we weigh the precipitate. This is accomplished by folding the filter paper over the precipitate and transferring both the filter paper and the precipitate to a porcelain or platinum crucible. Gentle heating first dries and then chars the filter paper. Once the paper begins to char, we slowly increase the temperature until there is no trace of the filter paper and any remaining carbon is oxidized to CO_2 .

Fritted-glass crucibles can not withstand high temperatures and are dried in an oven at a temperature below 200°C . The glass fiber mats used in Gooch crucibles can be heated to a maximum temperature of approximately 500°C .

COMPOSITION OF THE FINAL PRECIPITATE

For a quantitative application, the final precipitate must have a well-defined composition. A precipitate that contains volatile ions or substantial amounts of hydrated water, usually is dried at a temperature that com-

pletely removes these volatile species. For example, one standard gravimetric method for the determination of magnesium involves its precipitation as $\text{MgNH}_4\text{PO}_4 \cdot 6\text{H}_2\text{O}$. Unfortunately, this precipitate is difficult to dry at lower temperatures without losing an inconsistent amount of hydrated water and ammonia. Instead, the precipitate is dried at a temperature greater than 1000°C where it decomposes to magnesium pyrophosphate, $\text{Mg}_2\text{P}_2\text{O}_7$.

An additional problem is encountered if the isolated solid is nonstoichiometric. For example, precipitating Mn^{2+} as $\text{Mn}(\text{OH})_2$ and heating frequently produces a nonstoichiometric manganese oxide, MnO_x , where x varies between one and two. In this case the nonstoichiometric product is the result of forming a mixture of oxides with different oxidation state of manganese. Other nonstoichiometric compounds form as a result of lattice defects in the crystal structure.⁷

⁷ Ward, R., ed., *Non-Stoichiometric Compounds (Ad. Chem. Ser. 39)*, American Chemical Society: Washington, D. C., 1963.

The best way to appreciate the theoretical and practical details discussed in this section is to carefully examine a typical precipitation gravimetric method. Although each method is unique, the determination of Mg^{2+} in water and wastewater by precipitating $\text{MgNH}_4\text{PO}_4 \cdot 6\text{H}_2\text{O}$ and isolating $\text{Mg}_2\text{P}_2\text{O}_7$ provides an instructive example of a typical procedure. The description here is based on Method 3500-Mg D in *Standard Methods for the Examination of Water and Wastewater*, 19th Ed., American Public Health Association: Washington, D. C., 1995. With the publication of the 20th Edition in 1998, this method is no longer listed as an approved method.

Representative Method 8.1

Determination of Mg^{2+} in Water and Wastewater

DESCRIPTION OF METHOD

Magnesium is precipitated as $\text{MgNH}_4\text{PO}_4 \cdot 6\text{H}_2\text{O}$ using $(\text{NH}_4)_2\text{HPO}_4$ as the precipitant. The precipitate's solubility in a neutral solution is relatively high (0.0065 g/100 mL in pure water at 10°C), but it is much less soluble in the presence of dilute ammonia (0.0003 g/100 mL in 0.6 M NH_3). Because the precipitant is not selective, a preliminary separation of Mg^{2+} from potential interferents is necessary. Calcium, which is the most significant interferent, is removed by precipitating it as CaC_2O_4 . The presence of excess ammonium salts from the precipitant, or from the addition of too much ammonia, leads to the formation of $\text{Mg}(\text{NH}_4)_4(\text{PO}_4)_2$, which forms $\text{Mg}(\text{PO}_3)_2$ after drying. The precipitate is isolated by gravity filtration, using a rinse solution of dilute ammonia. After filtering, the precipitate is converted to $\text{Mg}_2\text{P}_2\text{O}_7$ and weighed.

PROCEDURE

Transfer a sample that contains no more than 60 mg of Mg^{2+} into a 600-mL beaker. Add 2–3 drops of methyl red indicator, and, if necessary, adjust the volume to 150 mL. Acidify the solution with 6 M HCl and add 10 mL of 30% w/v $(\text{NH}_4)_2\text{HPO}_4$. After cooling and with constant stirring, add concentrated NH_3 dropwise until the methyl red indicator turns yellow ($\text{pH} > 6.3$). After stirring for 5 min, add 5 mL of concentrated NH_3 and continue to stir for an additional 10 min. Allow the resulting solution and precipitate to stand overnight. Isolate the precipitate by filtering through filter paper, rinsing with 5% v/v NH_3 . Dissolve the precipitate in 50 mL of 10% v/v HCl and precipitate a second time following the same

procedure. After filtering, carefully remove the filter paper by charring. Heat the precipitate at 500 °C until the residue is white, and then bring the precipitate to constant weight at 1100 °C.

QUESTIONS

1. Why does the procedure call for a sample that contains no more than 60 mg of Mg^{2+} ?

A 60-mg portion of Mg^{2+} generates approximately 600 mg of $\text{MgNH}_4\text{PO}_4 \cdot 6\text{H}_2\text{O}$, which is a substantial amount of precipitate. A larger quantity of precipitate is difficult to filter and difficult to rinse free of impurities.

2. Why is the solution acidified with HCl before we add the precipitant?

The HCl ensures that $\text{MgNH}_4\text{PO}_4 \cdot 6\text{H}_2\text{O}$ does not precipitate immediately upon adding the precipitant. Because PO_4^{3-} is a weak base, the precipitate is soluble in a strongly acidic solution. If we add the precipitant under neutral or basic conditions (that is, a high *RSS*), then the resulting precipitate will consist of smaller, less pure particles. Increasing the pH by adding base allows the precipitate to form under more favorable (that is, a low *RSS*) conditions.

3. Why is the acid–base indicator methyl red added to the solution?

The indicator changes color at a pH of approximately 6.3, which indicates that there is sufficient NH_3 to neutralize the HCl added at the beginning of the procedure. The amount of NH_3 is crucial to this procedure. If we add insufficient NH_3 , then the solution is too acidic, which increases the precipitate's solubility and leads to a negative determinate error. If we add too much NH_3 , the precipitate may contain traces of $\text{Mg}(\text{NH}_4)_4(\text{PO}_4)_2$, which, on drying, forms $\text{Mg}(\text{PO}_3)_2$ instead of $\text{Mg}_2\text{P}_2\text{O}_7$. This increases the mass of the ignited precipitate, and gives a positive determinate error. After adding enough NH_3 to neutralize the HCl, we add an additional 5 mL of NH_3 to complete the quantitative precipitation of $\text{MgNH}_4\text{PO}_4 \cdot 6\text{H}_2\text{O}$.

4. Explain why forming $\text{Mg}(\text{PO}_3)_2$ instead of $\text{Mg}_2\text{P}_2\text{O}_7$ increases the precipitate's mass.

Each mole of $\text{Mg}_2\text{P}_2\text{O}_7$ contains two moles of phosphorous and each mole of $\text{Mg}(\text{PO}_3)_2$ contains only one mole of phosphorous. A conservation of mass, therefore, requires that two moles of $\text{Mg}(\text{PO}_3)_2$ form in place of each mole of $\text{Mg}_2\text{P}_2\text{O}_7$. One mole of $\text{Mg}_2\text{P}_2\text{O}_7$ weighs 222.6 g. Two moles of $\text{Mg}(\text{PO}_3)_2$ weigh 364.5 g. Any replacement of $\text{Mg}_2\text{P}_2\text{O}_7$ with $\text{Mg}(\text{PO}_3)_2$ must increase the precipitate's mass.

5. What additional steps, beyond those discussed in questions 2 and 3, help improve the precipitate's purity?

Two additional steps in the procedure help to form a precipitate that is free of impurities: digestion and reprecipitation.

6. Why is the precipitate rinsed with a solution of 5% v/v NH_3 ?

This is done for the same reason that the precipitation is carried out in an ammoniacal solution; using dilute ammonia minimizes solubility losses when we rinse the precipitate.

8B.2 Quantitative Applications

Although no longer a common analytical technique, precipitation gravimetry still provides a reliable approach for assessing the accuracy of other methods of analysis, or for verifying the composition of standard reference materials. In this section we review the general application of precipitation gravimetry to the analysis of inorganic and organic compounds.

INORGANIC ANALYSIS

[Table 8.1](#) provides a summary of precipitation gravimetric methods for inorganic cations and anions. Several methods for the homogeneous generation of precipitants are shown in [Table 8.2](#). The majority of inorganic precipitants show poor selectivity for the analyte. Many organic precipitants, however, are selective for one or two inorganic ions. [Table 8.3](#) lists examples of several common organic precipitants.

Precipitation gravimetry continues to be listed as a standard method for the determination of SO_4^{2-} in water and wastewater analysis.⁸ Precipitation is carried out using BaCl_2 in an acidic solution (adjusted with HCl to a pH of 4.5–5.0) to prevent the precipitation of BaCO_3 or $\text{Ba}_3(\text{PO}_4)_2$, and at a temperature near the solution's boiling point. The precipitate is digested at 80–90 °C for at least two hours. Ashless filter paper pulp is added to the precipitate to aid in its filtration. After filtering, the precipitate is ignited to constant weight at 800 °C. Alternatively, the precipitate is filtered through a fine porosity fritted glass crucible (without adding filter paper pulp), and dried to constant weight at 105 °C. This procedure is subject to a variety of errors, including occlusions of $\text{Ba}(\text{NO}_3)_2$, BaCl_2 , and alkali sulfates.

ORGANIC ANALYSIS

Several organic functional groups or heteroatoms can be determined using precipitation gravimetric methods. [Table 8.4](#) provides a summary of several representative examples. Note that the determination of alkoxy functional groups is an indirect analysis in which the functional group reacts with and excess of HI and the unreacted I^- determined by precipitating as AgCl .

Other standard methods for the determination of sulfate in water and wastewater include ion chromatography (see Chapter 12), capillary ion electrophoresis (see Chapter 12), turbidimetry (see Chapter 10), and flow injection analysis (see Chapter 13).

⁸ Method 4500- SO_4^{2-} -C and Method 4500- SO_4^{2-} -D as published in *Standard Methods for the Examination of Waters and Wastewaters*, 20th Ed., American Public Health Association: Washington, D. C., 1998.

Table 8.1 Selected Precipitation Gravimetric Methods for Inorganic Cations and Anions (Arranged by Precipitant)

Analyte	Precipitant	Precipitate Formed	Precipitate Weighed
Ba ²⁺	(NH ₄) ₂ CrO ₄	BaCrO ₄	BaCrO ₄
Pb ²⁺	K ₂ CrO ₄	PbCrO ₄	PbCrO ₄
Ag ⁺	HCl	AgCl	AgCl
Hg ₂ ²⁺	HCl	Hg ₂ Cl ₂	Hg ₂ Cl ₂
Al ³⁺	NH ₃	Al(OH) ₃	Al ₂ O ₃
Be ²⁺	NH ₃	Be(OH) ₂	BeO
Fe ³⁺	NH ₃	Fe(OH) ₃	Fe ₂ O ₃
Ca ²⁺	(NH ₄) ₂ C ₂ O ₄	CaC ₂ O ₄	CaCO ₃ or CaO
Sb ³⁺	H ₂ S	Sb ₂ S ₃	Sb ₂ S ₃
As ³⁺	H ₂ S	As ₂ S ₃	As ₂ S ₃
Hg ²⁺	H ₂ S	HgS	HgS
Ba ²⁺	H ₂ SO ₄	BaSO ₄	BaSO ₄
Pb ²⁺	H ₂ SO ₄	PbSO ₄	PbSO ₄
Sr ²⁺	H ₂ SO ₄	SrSO ₄	SrSO ₄
Be ³⁺	(NH ₄) ₂ HPO ₄	NH ₄ BePO ₄	Be ₂ P ₂ O ₇
Mg ²⁺	(NH ₄) ₂ HPO ₄	NH ₄ MgPO ₄	Mg ₂ P ₂ O ₇
Zn ²⁺	(NH ₄) ₂ HPO ₄	NH ₄ ZnPO ₄	Zn ₂ P ₂ O ₇
Sr ²⁺	KH ₂ PO ₄	SrHPO ₄	Sr ₂ P ₂ O ₇
CN ⁻	AgNO ₃	AgCN	AgCN
I ⁻	AgNO ₃	AgI	AgI
Br ⁻	AgNO ₃	AgBr	AgBr
Cl ⁻	AgNO ₃	AgCl	AgCl
ClO ₃ ⁻	FeSO ₄ /AgNO ₃	AgCl	AgCl
SCN ⁻	SO ₂ /CuSO ₄	CuSCN	CuSCN
SO ₄ ²⁻	BaCl ₂	BaSO ₄	BaSO ₄

QUANTITATIVE CALCULATIONS

The stoichiometry of a precipitation reaction provides a mathematical relationship between the analyte and the precipitate. Because a precipitation gravimetric method may involve additional chemical reactions to bring the analyte into a different chemical form, knowing the stoichiometry of the precipitation reaction is not always sufficient. Even if you do not have a complete set of balanced chemical reactions, you can use a conservation of mass to deduce the mathematical relationship between the analyte and the precipitate. The following example demonstrates this approach for the direct analysis of a single analyte.

Table 8.2 Reactions for the Homogeneous Preparation of Selected Inorganic Precipitants

Precipitant	Reaction
OH^-	$(\text{NH}_2)_2\text{CO}(\text{aq}) + 3\text{H}_2\text{O}(\text{l}) \rightleftharpoons 2\text{NH}_4^+(\text{aq}) + \text{CO}_2(\text{g}) + 2\text{OH}^-(\text{aq})$
SO_4^{2-}	$\text{NH}_2\text{HSO}_3(\text{aq}) + 2\text{H}_2\text{O}(\text{l}) \rightleftharpoons \text{NH}_4^+(\text{aq}) + \text{H}_3\text{O}^+(\text{aq}) + \text{SO}_4^{2-}(\text{aq})$
S^{2-}	$\text{CH}_3\text{CSNH}_2(\text{aq}) + \text{H}_2\text{O}(\text{l}) \rightleftharpoons \text{CH}_3\text{CONH}_2(\text{aq}) + \text{H}_2\text{S}(\text{aq})$
IO_3^-	$\text{HOCH}_2\text{CH}_2\text{OH}(\text{aq}) + \text{IO}_4^-(\text{aq}) \rightleftharpoons 2\text{HCHO}(\text{aq}) + \text{H}_2\text{O}(\text{l}) + \text{IO}_3^-(\text{aq})$
PO_4^{3-}	$(\text{CH}_3\text{O})_3\text{PO}(\text{aq}) + 3\text{H}_2\text{O}(\text{l}) \rightleftharpoons 3\text{CH}_3\text{OH}(\text{aq}) + \text{H}_3\text{PO}_4(\text{aq})$
$\text{C}_2\text{O}_4^{2-}$	$(\text{C}_2\text{H}_5)_2\text{C}_2\text{O}_4(\text{aq}) + 2\text{H}_2\text{O}(\text{l}) \rightleftharpoons 2\text{C}_2\text{H}_5\text{OH}(\text{aq}) + \text{H}_2\text{C}_2\text{O}_4(\text{aq})$
CO_3^{2-}	$\text{Cl}_3\text{CCOOH}(\text{aq}) + 2\text{OH}^-(\text{aq}) \rightleftharpoons \text{CHCl}_3(\text{aq}) + \text{CO}_3^{2-}(\text{aq}) + \text{H}_2\text{O}(\text{l})$

Table 8.3 Selected Precipitation Gravimetric Methods for Inorganic Ions Using an Organic Precipitant

Analyte	Precipitant	Structure	Precipitate Formed	Precipitate Weighed
Ni^{2+}	dimethylglyoxime		$\text{Ni}(\text{C}_4\text{H}_7\text{O}_2\text{N}_2)_2$	$\text{Ni}(\text{C}_4\text{H}_7\text{O}_2\text{N}_2)_2$
Fe^{3+}	cupferron		$\text{Fe}(\text{C}_6\text{H}_5\text{N}_2\text{O}_2)_3$	Fe_2O_3
Cu^{2+}	cupron		$\text{CuC}_{14}\text{H}_{11}\text{O}_2\text{N}$	$\text{CuC}_{14}\text{H}_{11}\text{O}_2\text{N}$
Co^{2+}	1-nitroso-2-naphthol		$\text{Co}(\text{C}_{10}\text{H}_6\text{O}_2\text{N})_3$	Co or CoSO_4
K^+	sodium tetraphenylborate	$\text{Na}[\text{B}(\text{C}_6\text{H}_5)_4]$	$\text{K}[\text{B}(\text{C}_6\text{H}_5)_4]$	$\text{K}[\text{B}(\text{C}_6\text{H}_5)_4]$
NO_3^-	nitron		$\text{C}_{20}\text{H}_{16}\text{N}_4\text{HNO}_3$	$\text{C}_{20}\text{H}_{16}\text{N}_4\text{H-NO}_3$

Table 8.4 Selected Precipitation Gravimetric Methods for the Analysis of Organic Functional Groups and Heteroatoms

Analyte	Treatment	Precipitant	Precipitate
Organic halides R-X X = Cl, Br, I	Oxidation with HNO ₃ in the presence of Ag ⁺	AgNO ₃	AgX
Organic halides R-X X = Cl, Br, I	Combustion in O ₂ (with a Pt catalyst) in the presence of Ag ⁺	AgNO ₃	AgX
Organic sulfur	Oxidation with HNO ₃ in the presence of Ba ²⁺	BaCl ₂	BaSO ₄
Organic sulfur	Combustion in O ₂ (with Pt catalyst) with SO ₂ and SO ₃ collected in dilute H ₂ O ₂	BaCl ₂	BaSO ₄
Alkoxy groups -O-R or -COO-R R = CH ₃ or C ₂ H ₅	Reaction with HI to produce RI	AgNO ₃	AgI

Example 8.1

To determine the amount of magnetite, Fe₃O₄, in an impure ore, a 1.5419-g sample is dissolved in concentrated HCl, resulting in a mixture of Fe²⁺ and Fe³⁺. After adding HNO₃ to oxidize Fe²⁺ to Fe³⁺ and diluting with water, Fe³⁺ is precipitated as Fe(OH)₃ using NH₃. Filtering, rinsing, and igniting the precipitate provides 0.8525 g of pure Fe₂O₃. Calculate the %w/w Fe₃O₄ in the sample.

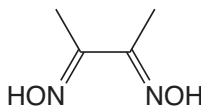
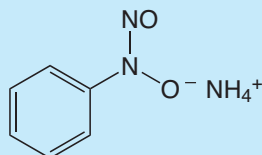
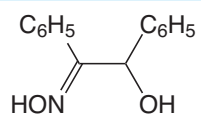
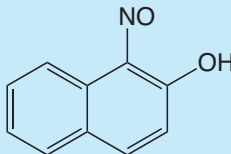
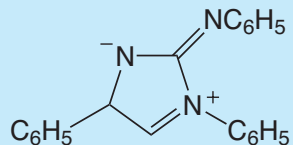
SOLUTION

A conservation of mass requires that the precipitate of Fe₂O₃ contain all iron originally in the sample of ore. We know there are 2 moles of Fe per mole of Fe₂O₃ (FW = 159.69 g/mol) and 3 moles of Fe per mole of Fe₃O₄ (FW = 231.54 g/mol); thus

$$0.8525 \text{ g Fe}_2\text{O}_3 \times \frac{2 \text{ mol Fe}}{159.69 \text{ g Fe}_2\text{O}_3} \times \frac{231.54 \text{ g Fe}_3\text{O}_4}{3 \text{ mol Fe}} = 0.82405 \text{ g Fe}_3\text{O}_4$$

The % w/w Fe₃O₄ in the sample, therefore, is

$$\frac{0.82405 \text{ g Fe}_3\text{O}_4}{1.5419 \text{ g sample}} \times 100 = 53.44\%$$

Practice Exercise 8.2

A 0.7336-g sample of an alloy that contains copper and zinc is dissolved in 8 M HCl and diluted to 100 mL in a volumetric flask. In one analysis, the zinc in a 25.00-mL portion of the solution is precipitated as ZnNH₄PO₄, and isolated as Zn₂P₂O₇, yielding 0.1163 g. The copper in a separate 25.00-mL portion of the solution is treated to precipitate CuSCN, yielding 0.2383 g. Calculate the %w/w Zn and the %w/w Cu in the sample.

Click [here](#) to review your answer to this exercise.

In Practice Exercise 8.2 the sample contains two analytes. Because we can precipitate each analyte selectively, finding their respective concentrations is a straightforward stoichiometric calculation. But what if we cannot separately precipitate the two analytes? To find the concentrations of both

analytes, we still need to generate two precipitates, at least one of which must contain both analytes. Although this complicates the calculations, we can still use a conservation of mass to solve the problem.

Example 8.2

A 0.611-g sample of an alloy that contains Al and Mg is dissolved and treated to prevent interferences by the alloy's other constituents. Aluminum and magnesium are precipitated using 8-hydroxyquinoline, which yields a mixed precipitate of $\text{Al}(\text{C}_9\text{H}_6\text{NO})_3$ and $\text{Mg}(\text{C}_9\text{H}_6\text{NO})_2$ that weighs 7.815 g. Igniting the precipitate converts it to a mixture of Al_2O_3 and MgO that weighs 1.002 g. Calculate the %w/w Al and %w/w Mg in the alloy.

SOLUTION

The masses of the solids provide us with the following two equations.

$$\text{g Al}(\text{C}_9\text{H}_6\text{NO})_3 + \text{g Mg}(\text{C}_9\text{H}_6\text{NO})_2 = 7.815 \text{ g}$$

$$\text{g Al}_2\text{O}_3 + \text{g MgO} = 1.002 \text{ g}$$

With two equations and four unknowns, we need two additional equations to solve the problem. A conservation of mass requires that all the aluminum in $\text{Al}(\text{C}_9\text{H}_6\text{NO})_3$ also is in Al_2O_3 ; thus

$$\begin{aligned} \text{g Al}_2\text{O}_3 &= \text{g Al}(\text{C}_9\text{H}_6\text{NO})_3 \times \\ &\quad \frac{1 \text{ mol Al}}{459.43 \text{ g Al}(\text{C}_9\text{H}_6\text{NO})_3} \times \frac{101.96 \text{ g Al}_2\text{O}_3}{2 \text{ mol Al}_2\text{O}_3} \\ \text{g Al}_2\text{O}_3 &= 0.11096 \times \text{g Al}(\text{C}_9\text{H}_6\text{NO})_3 \end{aligned}$$

Using the same approach, a conservation of mass for magnesium gives

$$\begin{aligned} \text{g MgO} &= \text{g Mg}(\text{C}_9\text{H}_6\text{NO})_2 \times \\ &\quad \frac{1 \text{ mol Mg}}{312.61 \text{ g Mg}(\text{C}_9\text{H}_6\text{NO})_2} \times \frac{40.304 \text{ g MgO}}{\text{mol MgO}} \\ \text{g MgO} &= 0.12893 \times \text{g Mg}(\text{C}_9\text{H}_6\text{NO})_2 \end{aligned}$$

Substituting the equations for g MgO and g Al_2O_3 into the equation for the combined weights of MgO and Al_2O_3 leaves us with two equations and two unknowns.

$$\text{g Al}(\text{C}_9\text{H}_6\text{NO})_3 + \text{g Mg}(\text{C}_9\text{H}_6\text{NO})_2 = 7.815 \text{ g}$$

$$\begin{aligned} 0.11096 \times \text{g Al}(\text{C}_9\text{H}_6\text{NO})_3 + \\ 0.12893 \times \text{g Mg}(\text{C}_9\text{H}_6\text{NO})_2 &= 1.002 \text{ g} \end{aligned}$$

Multiplying the first equation by 0.11096 and subtracting the second equation gives

$$-0.01797 \times \text{g Mg}(\text{C}_9\text{H}_6\text{NO})_2 = -0.1348 \text{ g}$$

$$\text{g Mg}(\text{C}_9\text{H}_6\text{NO})_2 = 7.504 \text{ g}$$

$$g \text{ Al}(\text{C}_9\text{H}_6\text{NO})_3 = 7.815 \text{ g} - 7.504 \text{ g Mg}(\text{C}_9\text{H}_6\text{NO})_2 = 0.311 \text{ g}$$

Now we can finish the problem using the approach from [Example 8.1](#). A conservation of mass requires that all the aluminum and magnesium in the original sample of Dow metal is in the precipitates of $\text{Al}(\text{C}_9\text{H}_6\text{NO})_3$ and the $\text{Mg}(\text{C}_9\text{H}_6\text{NO})_2$. For aluminum, we find that

$$0.311 \text{ g Al}(\text{C}_9\text{H}_6\text{NO})_3 \times \frac{1 \text{ mol Al}}{459.45 \text{ g Al}(\text{C}_9\text{H}_6\text{NO})_3} \times \frac{26.982 \text{ g Al}}{\text{mol Al}} = 0.01826 \text{ g Al}$$

$$\frac{0.01826 \text{ g Al}}{0.611 \text{ g sample}} \times 100 = 2.99\% \text{ w/w Al}$$

and for magnesium we have

$$7.504 \text{ g Mg}(\text{C}_9\text{H}_6\text{NO})_2 \times \frac{1 \text{ mol Mg}}{312.61 \text{ g Mg}(\text{C}_9\text{H}_6\text{NO})_2} \times \frac{24.305 \text{ g Mg}}{\text{mol MgO}} = 0.5834 \text{ g Mg}$$

$$\frac{0.5834 \text{ g Mg}}{0.611 \text{ g sample}} \times 100 = 95.5\% \text{ w/w Mg}$$

Practice Exercise 8.3

A sample of a silicate rock that weighs 0.8143 g is brought into solution and treated to yield a 0.2692-g mixture of NaCl and KCl. The mixture of chloride salts is dissolved in a mixture of ethanol and water, and treated with HClO_4 , precipitating 0.5713 g of KClO_4 . What is the %w/w Na_2O in the silicate rock?

Click [here](#) to review your answer to this exercise.

The previous problems are examples of direct methods of analysis because the precipitate contains the analyte. In an indirect analysis the precipitate forms as a result of a reaction with the analyte, but the analyte is not part of the precipitate. As shown by the following example, despite the additional complexity, we still can use conservation principles to organize our calculations.

Example 8.3

An impure sample of Na_3PO_3 that weighs 0.1392 g is dissolved in 25 mL of water. A second solution that contains 50 mL of 3% w/v HgCl_2 , 20 mL of 10% w/v sodium acetate, and 5 mL of glacial acetic acid is prepared. Adding the solution that contains the sample to the second solution oxidizes PO_3^{3-} to PO_4^{3-} and precipitates Hg_2Cl_2 . After digesting, filtering, and rinsing the precipitate, 0.4320 g of Hg_2Cl_2 is obtained. Report the purity of the original sample as % w/w Na_3PO_3 .

Although you can write the balanced reactions for any analysis, applying conservation principles can save you a significant amount of time!

As you become comfortable using conservation principles, you will see ways to further simplify problems. For example, a conservation of electrons requires that the electrons released by Na_3PO_3 end up in the product, Hg_2Cl_2 , yielding the following stoichiometric conversion factor:

$$\frac{2 \text{ mol Na}_3\text{PO}_3}{\text{mol Hg}_2\text{Cl}_2}$$

This conversion factor provides a direct link between the mass of Hg_2Cl_2 and the mass of Na_3PO_3 .

SOLUTION

This is an example of an indirect analysis because the precipitate, Hg_2Cl_2 , does not contain the analyte, Na_3PO_3 . Although the stoichiometry of the reaction between Na_3PO_3 and HgCl_2 is given [earlier](#) in the chapter, let's see how we can solve the problem using conservation principles.

The reaction between Na_3PO_3 and HgCl_2 is an oxidation-reduction reaction in which phosphorous increases its oxidation state from +3 in Na_3PO_3 to +5 in Na_3PO_4 , and in which mercury decreases its oxidation state from +2 in HgCl_2 to +1 in Hg_2Cl_2 . A redox reaction must obey a conservation of electrons because all the electrons released by the reducing agent, Na_3PO_3 , must be accepted by the oxidizing agent, HgCl_2 . Knowing this, we write the following stoichiometric conversion factors:

$$\frac{2 \text{ mol } e^-}{\text{mol Na}_3\text{PO}_3} \quad \text{and} \quad \frac{1 \text{ mol } e^-}{\text{mol HgCl}_2}$$

Now we are ready to solve the problem. First, we use a conservation of mass for mercury to convert the precipitate's mass to the moles of HgCl_2 .

$$0.4320 \text{ g Hg}_2\text{Cl}_2 \times \frac{2 \text{ mol Hg}}{472.09 \text{ g Hg}_2\text{Cl}_2} \times \frac{1 \text{ mol HgCl}_2}{\text{mol Hg}} = 1.8302 \times 10^{-3} \text{ mol HgCl}_2$$

Next, we use the conservation of electrons to find the mass of Na_3PO_3 .

$$1.8302 \times 10^{-3} \text{ mol HgCl}_2 \times \frac{1 \text{ mol } e^-}{\text{mol HgCl}_2} \times \frac{1 \text{ mol Na}_3\text{PO}_3}{2 \text{ mol } e^-} \times \frac{147.94 \text{ g Na}_3\text{PO}_3}{\text{mol Na}_3\text{PO}_3} = 0.13538 \text{ g Na}_3\text{PO}_3$$

Finally, we calculate the %w/w Na_3PO_3 in the sample.

$$\frac{0.13538 \text{ g Na}_3\text{PO}_3}{0.1392 \text{ g sample}} \times 100 = 97.26\% \text{ w/w Na}_3\text{PO}_3$$

Practice Exercise 8.4

One approach for determining phosphate, PO_4^{3-} , is to precipitate it as ammonium phosphomolybdate, $(\text{NH}_4)_3\text{PO}_4 \cdot 12\text{MoO}_3$. After we isolate the precipitate by filtration, we dissolve it in acid and precipitate and weigh the molybdate as PbMoO_3 . Suppose we know that our sample is at least 12.5% Na_3PO_4 and that we need to recover a minimum of 0.600 g of PbMoO_3 ? What is the minimum amount of sample that we need for each analysis?

Click [here](#) to review your answer to this exercise.

8B.2 Qualitative Applications

A precipitation reaction is a useful method for identifying inorganic and organic analytes. Because a qualitative analysis does not require quantitative measurements, the analytical signal is simply the observation that a precipitate forms. Although qualitative applications of precipitation gravimetry have been replaced by spectroscopic methods of analysis, they continue to find application in spot testing for the presence of specific analytes.⁹

Any of the precipitants listed in [Table 8.1](#), [Table 8.3](#), and [Table 8.4](#) can be used for a qualitative analysis.

8B.3 Evaluating Precipitation Gravimetry

SCALE OF OPERATION

The scale of operation for precipitation gravimetry is limited by the sensitivity of the balance and the availability of sample. To achieve an accuracy of $\pm 0.1\%$ using an analytical balance with a sensitivity of ± 0.1 mg, we must isolate at least 100 mg of precipitate. As a consequence, precipitation gravimetry usually is limited to major or minor analytes, in macro or meso samples (see [Figure 3.5](#) in Chapter 3). The analysis of a trace level analyte or a micro sample requires a microanalytical balance.

ACCURACY

For a macro sample that contains a major analyte, a relative error of 0.1–0.2% is achieved routinely. The principle limitations are solubility losses, impurities in the precipitate, and the loss of precipitate during handling. When it is difficult to obtain a precipitate that is free from impurities, it often is possible to determine an empirical relationship between the precipitate's mass and the mass of the analyte by an appropriate calibration.

[Problem 8.27](#) provides an example of how to determine an analyte's concentration by establishing an empirical relationship between the analyte and the precipitate.

PRECISION

The relative precision of precipitation gravimetry depends on the sample's size and the precipitate's mass. For a smaller amount of sample or precipitate, a relative precision of 1–2 ppt is obtained routinely. When working with larger amounts of sample or precipitate, the relative precision extends to several ppm. Few quantitative techniques can achieve this level of precision.

SENSITIVITY

For any precipitation gravimetric method we can write the following general equation to relate the signal (grams of precipitate) to the absolute amount of analyte in the sample

$$\text{g precipitate} = k \times \text{g analyte} \quad 8.13$$

where k , the method's sensitivity, is determined by the stoichiometry between the precipitate and the analyte. Consider, for example, the determi-

Equation 8.13 assumes we used a suitable blank to correct the signal for any contributions of the reagent to the precipitate's mass.

⁹ Jungreis, E. *Spot Test Analysis*; 2nd Ed., Wiley: New York, 1997.

nation of Fe as Fe_2O_3 . Using a conservation of mass for iron, the precipitate's mass is

$$\text{g Fe}_2\text{O}_3 = \text{g Fe} \times \frac{1 \text{ mol Fe}}{\text{AW Fe}} \times \frac{\text{FW Fe}_2\text{O}_3}{2 \text{ mol Fe}}$$

and the value of k is

$$k = \frac{1}{2} \times \frac{\text{FW Fe}_2\text{O}_3}{\text{AW Fe}} \quad 8.14$$

Practice Exercise 8.5

Suppose you wish to determine the amount of iron in a sample. Which of the following compounds— FeO , Fe_2O_3 , or Fe_3O_4 —provides the greatest sensitivity?

Click [here](#) to review your answer to this exercise.

As we can see from equation 8.14, there are two ways to improve a method's sensitivity. The most obvious way to improve sensitivity is to increase the ratio of the precipitate's molar mass to that of the analyte. In other words, it helps to form a precipitate with the largest possible formula weight. A less obvious way to improve a method's sensitivity is indicated by the term of $1/2$ in equation 8.14, which accounts for the stoichiometry between the analyte and precipitate. We can also improve sensitivity by forming a precipitate that contains fewer units of the analyte.

SELECTIVITY

Due to the chemical nature of the precipitation process, precipitants usually are not selective for a single analyte. For example, silver is not a selective precipitant for chloride because it also forms precipitates with bromide and with iodide. Interferents often are a serious problem and must be considered if accurate results are to be obtained.

TIME, COST, AND EQUIPMENT

Precipitation gravimetry is time intensive and rarely practical if you have a large number of samples to analyze; however, because much of the time invested in precipitation gravimetry does not require an analyst's immediate supervision, it is a practical alternative when working with only a few samples. Equipment needs are few—beakers, filtering devices, ovens or burners, and balances—inexpensive, routinely available in most laboratories, and easy to maintain.

8C Volatilization Gravimetry

A second approach to gravimetry is to thermally or chemically decompose the sample and measure the resulting change in its mass. Alternatively, we can trap and weigh a volatile decomposition product. Because the release of a volatile species is an essential part of these methods, we classify them collectively as volatilization gravimetric methods of analysis.

8C.1 Theory and Practice

Whether an analysis is direct or indirect, volatilization gravimetry usually requires that we know the products of the decomposition reaction. This rarely is a problem for organic compounds, which typically decompose to

form simple gases such as CO_2 , H_2O , and N_2 . For an inorganic compound, however, the products often depend on the decomposition temperature.

Thermogravimetry

One method for determining the products of a thermal decomposition is to monitor the sample's mass as a function of temperature, a process called **THERMOGRAVIMETRY**. Figure 8.10 shows a typical thermogram in which each change in mass—each “step” in the thermogram—represents the loss of a volatile product. As the following example illustrates, we can use a **THERMOGRAM** to identify a compound's decomposition reactions.

Example 8.4

The thermogram in Figure 8.10 shows the mass of a sample of calcium oxalate monohydrate, $\text{CaC}_2\text{O}_4 \cdot \text{H}_2\text{O}$, as a function of temperature. The original sample of 17.61 mg was heated from room temperature to 1000°C at a rate of 20°C per minute. For each step in the thermogram, identify the volatilization product and the solid residue that remains.

SOLUTION

From $100\text{--}250^\circ\text{C}$ the sample loses $17.61\text{ mg} - 15.44\text{ mg}$, or 2.17 mg , which is

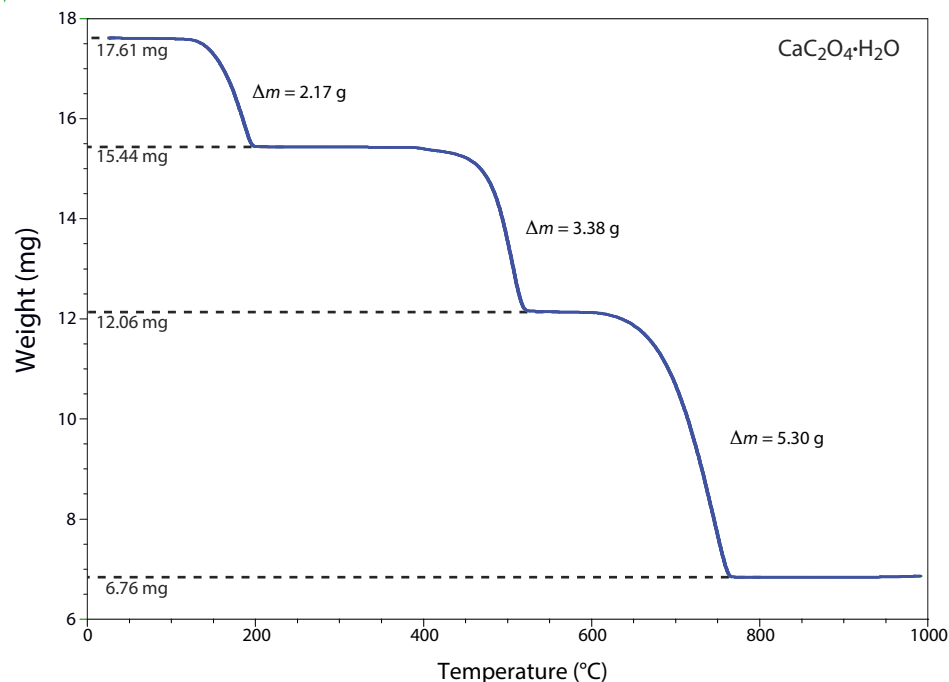

Figure 8.10 Thermogram for $\text{CaC}_2\text{O}_4 \cdot \text{H}_2\text{O}$ obtained by heating a sample from room temperature to 1000°C at a rate of $20^\circ\text{C}/\text{min}$. Each change in mass results from the loss of a volatile product. The sample's initial mass and its mass after each loss are shown by the dotted lines. See Example 8.4 for information on interpreting this thermogram.

$$\frac{2.17 \text{ mg}}{17.61 \text{ mg}} \times 100 = 12.3\%$$

of the sample's original mass. In terms of $\text{CaC}_2\text{O}_4 \cdot \text{H}_2\text{O}$, this corresponds to a decrease in the molar mass of

$$0.123 \times 146.11 \text{ g/mol} = 18.0 \text{ g/mol}$$

The product's molar mass and the temperature range for the decomposition, suggest that this is a loss of $\text{H}_2\text{O}(g)$, leaving a residue of CaC_2O_4 .

The loss of 3.38 mg from 350–550 °C is a 19.2% decrease in the sample's original mass, or a decrease in the molar mass of

$$0.192 \times 146.11 \text{ g/mol} = 28.1 \text{ g/mol}$$

which is consistent with the loss of $\text{CO}(g)$ and a residue of CaCO_3 .

Finally, the loss of 5.30 mg from 600–800 °C is a 30.1% decrease in the sample's original mass, or a decrease in molar mass of

$$0.301 \times 146.11 \text{ g/mol} = 44.0 \text{ g/mol}$$

This loss in molar mass is consistent with the release of $\text{CO}_2(g)$, leaving a final residue of CaO .

The three decomposition reactions are



Identifying the products of a thermal decomposition provides information that we can use to develop an analytical procedure. For example, the thermogram in [Figure 8.10](#) shows that we must heat a precipitate of $\text{CaC}_2\text{O}_4 \cdot \text{H}_2\text{O}$ to a temperature between 250 and 400 °C if we wish to isolate and weigh CaC_2O_4 . Alternatively, heating the sample to 1000 °C allows us to isolate and weigh CaO .

Practice Exercise 8.6

Under the same conditions as [Figure 8.10](#), the thermogram for a 22.16 mg sample of $\text{MgC}_2\text{O}_4 \cdot \text{H}_2\text{O}$ shows two steps: a loss of 3.06 mg from 100–250 °C and a loss of 12.24 mg from 350–550 °C. For each step, identify the volatilization product and the solid residue that remains. Using your results from this exercise and the results from Example 8.4, explain how you can use thermogravimetry to analyze a mixture that contains $\text{CaC}_2\text{O}_4 \cdot \text{H}_2\text{O}$ and $\text{MgC}_2\text{O}_4 \cdot \text{H}_2\text{O}$. You may assume that other components in the sample are inert and thermally stable below 1000 °C.

Click [here](#) to review your answer to this exercise.

EQUIPMENT

Depending on the method of analysis, the equipment for volatilization gravimetry may be simple or complex. In the simplest experimental design, we place the sample in a crucible and decompose it at a fixed temperature using a Bunsen burner, a Meker burner, a laboratory oven, or a muffle fur-

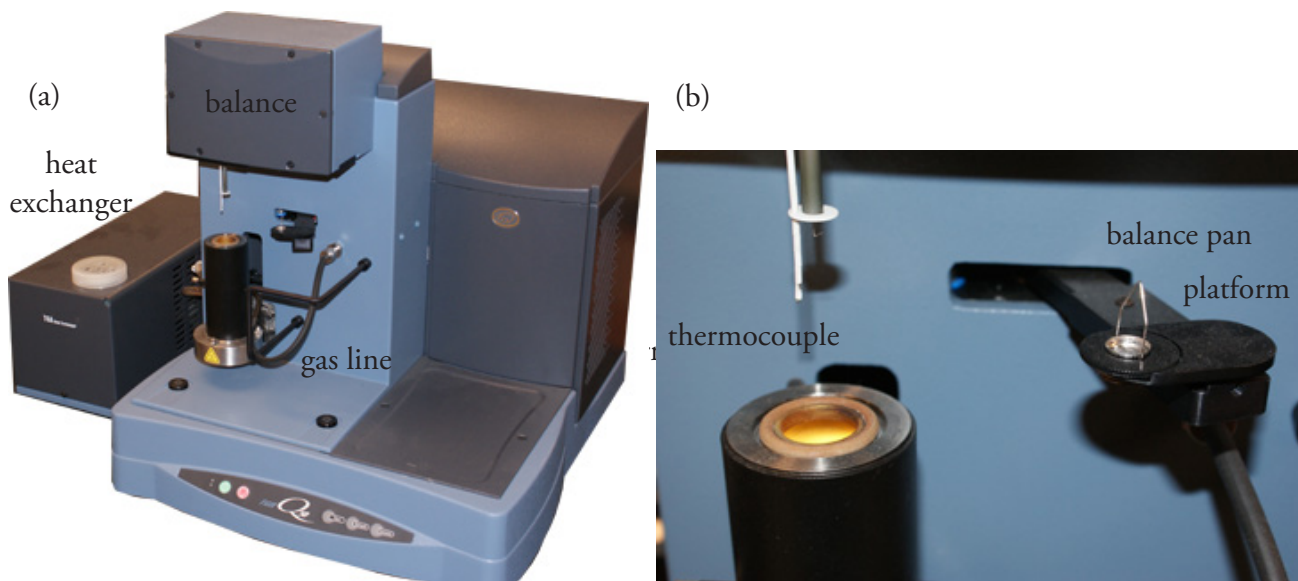

Figure 8.11 (a) Instrumentation for conducting a thermogravimetric analysis. The balance sits on the top of the instrument with the sample suspended below. A gas line supplies an inert gas that sweeps the volatile decomposition products out of the furnace. The heat exchanger dissipates the heat from the furnace to a reservoir of water. (b) Close-up showing the balance pan, which sits on a moving platform, the thermocouple for monitoring temperature, a hook for lowering the sample pan into the furnace, and the opening to the furnace. After placing a small portion of the sample on the balance pan, the platform rotates over the furnace and transfers the balance pan to a hook that is suspended from the balance. Once the balance pan is in place, the platform rotates back to its initial position. The balance pan and the thermocouple are then lowered into the furnace.

nance. The sample's mass and the mass of the residue are measured using an analytical balance.

Trapping and weighing the volatile products of a thermal decomposition requires specialized equipment. The sample is placed in a closed container and heated. As decomposition occurs, a stream of an inert purge-gas sweeps the volatile products through one or more selective absorbent traps.

In a thermogravimetric analysis, the sample is placed on a small balance pan attached to one arm of an electromagnetic balance (Figure 8.11). The sample is lowered into an electric furnace and the furnace's temperature is increased at a fixed rate of few degrees per minute while monitoring continuously the sample's weight. The instrument usually includes a gas line for purging the volatile decomposition products out of the furnace, and a heat exchanger to dissipate the heat emitted by the furnace.

Representative Method 8.2

Determination of Si in Ores and Alloys

DESCRIPTION OF METHOD

Silicon is determined by dissolving the sample in acid and dehydrating to precipitate SiO_2 . Because a variety of other insoluble oxides also form, the precipitate's mass is not a direct measure of the amount of silicon in the sample. Treating the solid residue with HF forms volatile SiF_4 . The

The best way to appreciate the theoretical and practical details discussed in this section is to carefully examine a typical volatilization gravimetric method. Although each method is unique, the determination of Si in ores and alloys by forming volatile SiF_4 provides an instructive example of a typical procedure. The description here is based on a procedure from Young, R. S. *Chemical Analysis in Extractive Metallurgy*, Griffen: London, 1971, pp. 302–304.

decrease in mass following the loss of SiF_4 provides an indirect measure of the amount of silicon in the original sample.

PROCEDURE

Transfer a sample of between 0.5 g and 5.0 g to a platinum crucible along with an excess of Na_2CO_3 , and heat until a melt forms. After cooling, dissolve the residue in dilute HCl. Evaporate the solution to dryness on a steam bath and heat the residue, which contains SiO_2 and other solids, for one hour at 110°C . Moisten the residue with HCl and repeat the dehydration. Remove any acid soluble materials from the residue by adding 50 mL of water and 5 mL of concentrated HCl. Bring the solution to a boil and filter through #40 filter paper. Wash the residue with hot 2% v/v HCl followed by hot water. Evaporate the filtrate to dryness twice and, following the same procedure, treat to remove any acid-soluble materials. Combine the two precipitates and dry and ignite to a constant weight at 1200°C . After cooling, add 2 drops of 50% v/v H_2SO_4 and 10 mL of HF. Remove the volatile SiF_4 by evaporating to dryness on a hot plate. Finally, bring the residue to constant weight by igniting at 1200°C .

QUESTIONS

1. According to the procedure the sample should weigh between 0.5 g and 5.0 g. How should you decide upon the amount of sample to use?

In this procedure the critical measurement is the decrease in mass following the volatilization of SiF_4 . The reaction responsible for the loss of mass is



Water and excess HF are removed during the final ignition, and do not contribute to the change in mass. The loss in mass, therefore, is equivalent to the mass of SiO_2 present after the dehydration step. Every 0.1 g of Si in the original sample results in the loss of 0.21 g of SiO_2 .

How much sample we use depends on what is an acceptable uncertainty when we measure its mass. A 0.5-g sample that is 50% w/w in Si, for example, will lose 0.53 g. If we are using a balance that measures mass to the nearest ± 0.1 mg, then the relative uncertainty in mass is approximately $\pm 0.02\%$; this is a reasonable level of uncertainty for a gravimetric analysis. A 0.5-g sample that is only 5% w/w Si experiences a weight loss of only 0.053 g and has a relative uncertainty of $\pm 0.2\%$. In this case a larger sample is needed.

2. Why are acid-soluble materials removed before we treat the dehydrated residue with HF?

Any acid-soluble materials in the sample will react with HF or H_2SO_4 . If the products of these reactions are volatile, or if they decompose at

#40 filter paper is a medium speed, ashless filter paper for filtering crystalline solids.

Problem 8.31 asks you to verify that this loss of mass is correct.

1200 °C, then the change in mass is not due solely to the volatilization of SiF_4 . As a result, we will overestimate the amount of Si in our sample.

3. Why is H_2SO_4 added with the HF?

Many samples that contain silicon also contain aluminum and iron, which form Al_2O_3 and Fe_2O_3 when we dehydrate the sample. These oxides are potential interferents because they also form volatile fluorides. In the presence of H_2SO_4 , however, aluminum and iron preferentially form non-volatile sulfates, which eventually decompose back to their respective oxides when we heat the residue to 1200 °C. As a result, the change in weight after treating with HF and H_2SO_4 is due only to the loss of SiF_4 .

8C.2 Quantitative Applications

Unlike precipitation gravimetry, which rarely is used as a standard method of analysis, volatilization gravimetric methods continue to play an important role in chemical analysis. Several important examples are discussed below.

INORGANIC ANALYSIS

Determining the inorganic ash content of an organic material, such as a polymer, is an example of a direct volatilization gravimetric analysis. After weighing the sample, it is placed in an appropriate crucible and the organic material carefully removed by combustion, leaving behind the inorganic ash. The crucible that contains the residue is heated to a constant weight using either a burner or an oven before the mass of the inorganic ash is determined.

Another example of volatilization gravimetry is the determination of dissolved solids in natural waters and wastewaters. In this method, a sample of water is transferred to a weighing dish and dried to a constant weight at either 103–105 °C or at 180 °C. Samples dried at the lower temperature retain some occluded water and lose some carbonate as CO_2 ; the loss of organic material, however, is minimal at this temperature. At the higher temperature, the residue is free from occluded water, but the loss of carbonate is greater. In addition, some chloride, nitrate, and organic material is lost through thermal decomposition. In either case, the residue that remains after drying to a constant weight at 500 °C is the amount of fixed solids in the sample, and the loss in mass provides an indirect measure of the sample's volatile solids.

Indirect analyses based on the weight of a residue that remains after volatilization are used to determine moisture in a variety of products and to determine silica in waters, wastewaters, and rocks. Moisture is determined by drying a preweighed sample with an infrared lamp or a low temperature

oven. The difference between the original weight and the weight after drying equals the mass of water lost.

ORGANIC ANALYSIS

The most important application of volatilization gravimetry is for the elemental analysis of organic materials. During combustion with pure O_2 , many elements, such as carbon and hydrogen, are released as gaseous combustion products, such as $CO_2(g)$ and $H_2O(g)$. Passing the combustion products through preweighed tubes that contain selective absorbents and measuring the increase in each tube's mass provides a direct analysis for the mass of carbon and hydrogen in the sample.

Alkaline metals and earths in organic materials are determined by adding H_2SO_4 to the sample before combustion. After combustion is complete, the metal remains behind as a solid residue of metal sulfate. Silver, gold, and platinum are determined by burning the organic sample, leaving a metallic residue of Ag, Au, or Pt. Other metals are determined by adding HNO_3 before combustion, which leaves a residue of the metal oxide.

Volatilization gravimetry also is used to determine biomass in waters and wastewaters. Biomass is a water quality index that provides an indication of the total mass of organisms contained within a sample of water. A known volume of the sample is passed through a preweighed $0.45\text{-}\mu\text{m}$ membrane filter or a glass-fiber filter and dried at 105°C for 24 h. The residue's mass provides a direct measure of biomass. If samples are known to contain a substantial amount of dissolved inorganic solids, the residue is ignited at 500°C for one hour, which volatilizes the biomass. The resulting inorganic residue is wetted with distilled water to rehydrate any clay minerals and dried to a constant weight at 105°C . The difference in mass before and after ignition provides an indirect measure of biomass.

QUANTITATIVE CALCULATIONS

For some applications, such as determining the amount of inorganic ash in a polymer, a quantitative calculation is straightforward and does not require a balanced chemical reaction. For other applications, however, the relationship between the analyte and the analytical signal depends upon the stoichiometry of any relevant reactions. Once again, a conservation of mass is useful when solving problems.

Example 8.5

A 101.3-mg sample of an organic compound that contains chlorine is combusted in pure O_2 . The volatile gases are collected in absorbent traps with the trap for CO_2 increasing in mass by 167.6 mg and the trap for H_2O increasing in mass by 13.7-mg. A second sample of 121.8 mg is treated with concentrated HNO_3 , producing Cl_2 that reacts with Ag^+ to



Instead of measuring mass, modern instruments for completing an elemental analysis use gas chromatography (Chapter 12) or infrared spectroscopy (Chapter 10) to monitor the gaseous decomposition products.

form 262.7 mg of AgCl. Determine the compound's composition, as well as its empirical formula.

SOLUTION

A conservation of mass requires that all the carbon in the organic compound is in the CO₂ produced during combustion; thus

$$0.1676 \text{ g CO}_2 \times \frac{1 \text{ mol C}}{44.010 \text{ g CO}_2} \times \frac{12.011 \text{ g C}}{\text{mol C}} = 0.04574 \text{ g C}$$

$$\frac{0.04574 \text{ g C}}{0.1013 \text{ g sample}} \times 100 = 45.15\% \text{ w/w C}$$

Using the same approach for hydrogen and chlorine, we find that

$$0.0137 \text{ g H}_2\text{O} \times \frac{2 \text{ mol H}}{18.015 \text{ g H}_2\text{O}} \times \frac{1.008 \text{ g H}}{\text{mol H}} = 1.533 \times 10^{-3} \text{ g H}$$

$$\frac{1.533 \times 10^{-3} \text{ g H}}{0.1003 \text{ g sample}} \times 100 = 1.53\% \text{ w/w H}$$

$$0.2627 \text{ g AgCl} \times \frac{1 \text{ mol Cl}}{143.32 \text{ g AgCl}} \times \frac{35.453 \text{ g Cl}}{\text{mol Cl}} = 0.06498 \text{ g Cl}$$

$$\frac{0.06498 \text{ g Cl}}{0.1218 \text{ g sample}} \times 100 = 53.35\% \text{ w/w Cl}$$

Adding together the weight percents for C, H, and Cl gives a total of 100.03%; thus, the compound contains only these three elements. To determine the compound's empirical formula we note that a gram of sample contains 0.4515 g of C, 0.0153 g of H and 0.5335 g of Cl. Expressing each element in moles gives 0.0376 moles C, 0.0152 moles H and 0.0150 moles Cl. Hydrogen and chlorine are present in a 1:1 molar ratio. The molar ratio of C to moles of H or Cl is

$$\frac{\text{mol C}}{\text{mol H}} = \frac{\text{mol C}}{\text{mol Cl}} = \frac{0.0376}{0.0150} = 2.51 \approx 2.5$$

Thus, the simplest, or empirical formula for the compound is C₅H₂Cl₂.

In an indirect volatilization gravimetric analysis, the change in the sample's weight is proportional to the amount of analyte in the sample. Note that in the following example it is not necessary to apply a conservation of mass to relate the analytical signal to the analyte.

Example 8.6

A sample of slag from a blast furnace is analyzed for SiO₂ by decomposing a 0.5003-g sample with HCl, leaving a residue with a mass of 0.1414 g. After treating with HF and H₂SO₄, and evaporating the volatile SiF₄, a residue with a mass of 0.0183 g remains. Determine the %w/w SiO₂ in the sample.

SOLUTION

The difference in the residue's mass before and after volatilizing SiF_4 gives the mass of SiO_2 in the sample; thus the sample contains

$$0.1414 \text{ g} - 0.0183 \text{ g} = 0.1231 \text{ g SiO}_2$$

and the %w/w SiO_2 is

$$\frac{0.1231 \text{ g SiO}_2}{0.5003 \text{ g sample}} \times 100 = 24.61\% \text{ w/w SiO}_2$$

Practice Exercise 8.7

Heating a 0.3317-g mixture of CaC_2O_4 and MgC_2O_4 yields a residue of 0.1794 g at 600°C and a residue of 0.1294 g at 1000°C . Calculate the %w/w CaC_2O_4 in the sample. You may wish to review your answer to [Practice Exercise 8.6](#) as you consider this problem.

Click [here](#) to review your answer to this exercise.

Finally, for some quantitative applications we can compare the result for a sample to a similar result obtained using a standard.

Example 8.7

A 26.23-mg sample of $\text{MgC}_2\text{O}_4 \cdot \text{H}_2\text{O}$ and inert materials is heated to constant weight at 1200°C , leaving a residue that weighs 20.98 mg. A sample of pure $\text{MgC}_2\text{O}_4 \cdot \text{H}_2\text{O}$, when treated in the same fashion, undergoes a 69.08% change in its mass. Determine the %w/w $\text{MgC}_2\text{O}_4 \cdot \text{H}_2\text{O}$ in the sample.

SOLUTION

The change in the sample's mass is 5.25 mg, which corresponds to

$$5.25 \text{ mg lost} \times \frac{100.0 \text{ mg MgC}_2\text{O}_4 \cdot \text{H}_2\text{O}}{69.08 \text{ mg lost}} = 7.60 \text{ mg MgC}_2\text{O}_4 \cdot \text{H}_2\text{O}$$

The %w/w $\text{MgC}_2\text{O}_4 \cdot \text{H}_2\text{O}$ in the sample is

$$\frac{7.60 \text{ mg MgC}_2\text{O}_4 \cdot \text{H}_2\text{O}}{26.23 \text{ mg sample}} \times 100 = 29.0\% \text{ w/w MgC}_2\text{O}_4 \cdot \text{H}_2\text{O}$$

Alternatively, you can determine that the final product of the decomposition is MgO (see [Practice Exercise 8.6](#)) and use a conservation of mass for Mg to arrive at the same answer.

8C.3 Evaluating Volatilization Gravimetry

The scale of operation, accuracy, and precision of a gravimetric volatilization method is similar to that described in Section 8B.3 for precipitation gravimetry. The sensitivity of a direct analysis is fixed by the analyte's chemical form following combustion or volatilization. We can improve the sensitivity of an indirect analysis by choosing conditions that give the largest possible change in mass. For example, the thermogram in [Figure 8.10](#)

shows us that an indirect analysis for $\text{CaC}_2\text{O}_4 \cdot \text{H}_2\text{O}$ is more sensitive if we measure the change in mass following ignition at 1000°C than if we ignite the sample at 300°C .

Selectivity is not a problem for a direct analysis if we trap the analyte using a selective absorbent trap. A direct analysis based on the residue's weight following combustion or volatilization is possible if the residue contains only the analyte of interest. As noted earlier, an indirect analysis only is feasible when the change in mass results from the loss of a single volatile product that contains the analyte.

Volatilization gravimetric methods are time and labor intensive. Equipment needs are few, except when combustion gases must be trapped, or for a thermogravimetric analysis, when specialized instrumentation is needed.

8D Particulate Gravimetry

Precipitation and volatilization gravimetric methods require that the analyte, or some other species in the sample, participates in a chemical reaction. In a direct precipitation gravimetric analysis, for example, we convert a soluble analyte into an insoluble form that precipitates from solution. In some situations, however, the analyte already is present in a particulate form that is easy to separate from its liquid, gas, or solid matrix. When such a separation is possible, we can determine the analyte's mass without relying on a chemical reaction.

A particulate is any tiny portion of matter, whether it is a speck of dust, a globule of fat, or a molecule of ammonia. For particulate gravimetry we simply need a method to collect the particles and a balance to measure their mass.

8D.1 Theory and Practice

There are two methods for separating a particulate analyte from its matrix. The most common method is filtration, in which we separate solid particulates from their gas, liquid, or solid matrix. A second method, which is useful for gas particles, solutes, and solids, is an extraction.

FILTRATION

To separate solid particulates from their matrix we use gravity or apply suction from a vacuum pump or an aspirator to pull the sample through a filter. The type of filter we use depends upon the size of the solid particles and the sample's matrix. Filters for liquid samples are constructed from a variety of materials, including cellulose fibers, glass fibers, cellulose nitrate, and polytetrafluoroethylene (PTFE). Particle retention depends on the size of the filter's pores. Cellulose fiber filter papers range in pore size from $30\ \mu\text{m}$ to $2\text{--}3\ \mu\text{m}$. Glass fiber filters, manufactured using chemically inert borosilicate glass, are available with pore sizes between $2.5\ \mu\text{m}$ and $0.3\ \mu\text{m}$. Membrane filters, which are made from a variety of materials, including cellulose nitrate and PTFE, are available with pore sizes from $5.0\ \mu\text{m}$ to $0.1\ \mu\text{m}$.

For additional information, see our earlier discussion in this chapter on filtering precipitates, and the discussion in Chapter 7 of separations based on size.

Solid aerosol particulates are collected using either a single-stage or a multiple-stage filter. In a single-stage system, we pull the gas through a sin-



Figure 8.12 Three sieves with, from left to right, mesh sizes of 1700 μm , 500 μm , and 250 μm . Source: [BMK](#) (commons.wikimedia.com).

gle filter, which retains particles larger than the filter's pore size. To collect samples from a gas line, we place the filter directly in the line. Atmospheric gases are sampled with a high volume sampler that uses a vacuum pump to pull air through the filter at a rate of approximately 75 m^3/h . In either case, we can use the same filtering media for liquid samples to collect aerosol particulates. In a multiple-stage system, a series of filtering units separates the particles into two or more size ranges.

The particulates in a solid matrix are separated by size using one or more sieves (Figure 8.12). Sieves are available in a variety of mesh sizes, ranging from approximately 25 mm to 40 μm . By stacking together sieves of different mesh size, we can isolate particulates into several narrow size ranges. Using the sieves in Figure 8.12, for example, we can separate a solid into particles with diameters $>1700 \mu\text{m}$, with diameters between 1700 μm and 500 μm , with diameters between 500 μm and 250 μm , and those with a diameter $<250 \mu\text{m}$.

EXTRACTION

Filtering limits particulate gravimetry to solid analytes that are easy to separate from their matrix. We can extend particulate gravimetry to the analysis of gas phase analytes, solutes, and solids that are difficult to filter if we extract them with a suitable solvent. After the extraction, we evaporate the solvent and determine the analyte's mass. Alternatively, we can determine the analyte indirectly by measuring the change in the sample's mass after we extract the analyte.

Another method for extracting an analyte from its matrix is by adsorption onto a solid substrate, by absorption into a thin polymer film or chemical film coated on a solid substrate, or by chemically binding to a suitable receptor that is covalently bound to a solid substrate (Figure 8.13). Adsorption, absorption, and binding occur at the interface between the

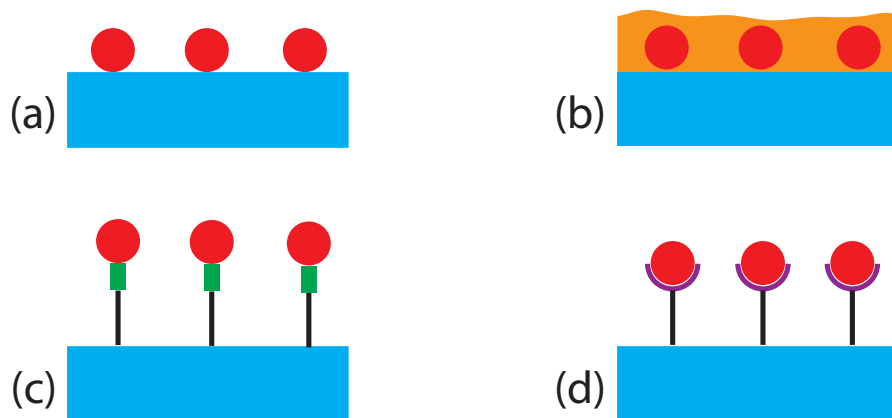

Figure 8.13 Four possible mechanisms for the solid-state extraction of an **analyte**: (a) adsorption onto a **solid substrate**; (b) absorption into a thin **polymer film** or **chemical film** coated on a solid substrate; (c) metal–ligand complexation in which the **ligand** is covalently bound to the solid substrate using an organic tether; and (d) antibody–antigen binding in which the **receptor** is covalently bound to the solid substrate using an organic tether.

For a more detailed review of extractions, particularly solid-phase extractions, see Chapter 7.

solution that contains the analyte and the substrate's surface, the thin film, or the receptor. Although the amount of extracted analyte is too small to measure using a conventional balance, it can be measured using a quartz crystal microbalance.

The measurement of mass using a **QUARTZ CRYSTAL MICROBALANCE** takes advantage of the piezoelectric effect.¹⁰ The application of an alternating electrical field across a quartz crystal induces an oscillatory vibrational motion in the crystal. Every quartz crystal vibrates at a characteristic resonant frequency that depends on the crystal's properties, including the mass per unit area of any material coated on the crystal's surface. The change in mass following adsorption, absorption, or binding of the analyte is determined by monitoring the change in the quartz crystal's characteristic resonant frequency. The exact relationship between the change in frequency and mass is determined by a calibration curve.

8D.2 Quantitative Applications

Particulate gravimetry is important in the environmental analysis of water, air, and soil samples. The analysis for suspended solids in water samples, for example, is accomplished by filtering an appropriate volume of a well-mixed sample through a glass fiber filter and drying the filter to constant weight at 103–105 °C.

The microbiological testing of water also uses particulate gravimetry. One example is the analysis for coliform bacteria in which an appropriate volume of sample is passed through a sterilized 0.45- μm membrane filter. The filter is placed on a sterilized absorbent pad that is saturated with a culturing medium and incubated for 22–24 hours at 35 ± 0.5 °C. Coliform bacteria are identified by the presence of individual bacterial colonies that form during the incubation period (Figure 8.14). As with qualitative applications of precipitation gravimetry, the signal in this case is a visual observation of the number of colonies rather than a measurement of mass.

Total airborne particulates are determined using a high-volume air sampler equipped with either a cellulose fiber or a glass fiber filter. Samples from urban environments require approximately 1 h of sampling time, but samples from rural environments require substantially longer times.

Grain size distributions for sediments and soils are used to determine the amount of sand, silt, and clay in a sample. For example, a grain size of 2 mm serves as the boundary between gravel and sand. The grain size for the sand–silt and the silt–clay boundaries are 1/16 mm and 1/256 mm, respectively.

Several standard quantitative analytical methods for agricultural products are based on measuring the sample's mass following a selective solvent extraction. For example, the crude fat content in chocolate is determined by

If you own a wristwatch, there is a good chance that its operation relies on a quartz crystal. The piezoelectric properties of quartz were discovered in 1880 by Paul-Jacques Currie and Pierre Currie. Because the oscillation frequency of a quartz crystal is so precise, it quickly found use in the keeping of time. The first quartz clock was built in 1927 at the Bell Telephone labs, and Seiko introduced the first quartz wristwatches in 1969.

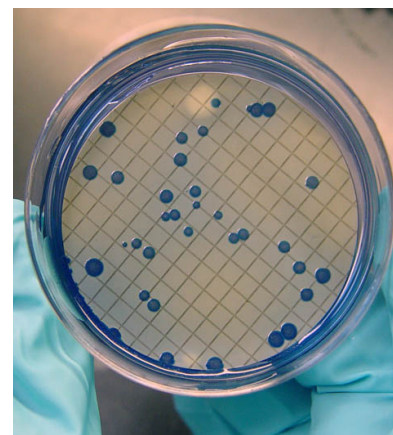

Figure 8.14 Colonies of fecal coliform bacteria from a water supply. Source: Susan Boyer. Photo courtesy of ARS–USDA (www.ars.usda.gov).

10 (a) Ward, M. D.; Buttry, D. A. *Science* **1990**, *249*, 1000–1007; (b) Grate, J. W.; Martin, S. J.; White, R. M. *Anal. Chem.* **1993**, *65*, 940A–948A; (c) Grate, J. W.; Martin, S. J.; White, R. M. *Anal. Chem.* **1993**, *65*, 987A–996A.

extracting with ether for 16 hours in a Soxhlet extractor. After the extraction is complete, the ether is allowed to evaporate and the residue is weighed after drying at 100 °C. This analysis also can be accomplished indirectly by weighing a sample before and after extracting with supercritical CO₂.

Quartz crystal microbalances equipped with thin film polymer films or chemical coatings have found numerous quantitative applications in environmental analysis. Methods are reported for the analysis of a variety of gaseous pollutants, including ammonia, hydrogen sulfide, ozone, sulfur dioxide, and mercury. Biochemical particulate gravimetric sensors also have been developed. For example, a piezoelectric immunosensor has been developed that shows a high selectivity for human serum albumin, and is capable of detecting microgram quantities.¹¹

QUANTITATIVE CALCULATIONS

The result of a quantitative analysis by particulate gravimetry is just the ratio, using appropriate units, of the amount of analyte relative to the amount of sample.

Example 8.8

A 200.0-mL sample of water is filtered through a pre-weighed glass fiber filter. After drying to constant weight at 105 °C, the filter is found to have increased in mass by 48.2 mg. Determine the sample's total suspended solids.

SOLUTION

One ppm is equivalent to one mg of analyte per liter of solution; thus, the total suspended solids for the sample is

$$\frac{48.2 \text{ mg solids}}{0.2000 \text{ L sample}} = 241 \text{ ppm solids}$$

8D.3 Evaluating Particulate Gravimetry

The scale of operation and the detection limit for particulate gravimetry can be extended beyond that of other gravimetric methods by increasing the size of the sample taken for analysis. This usually is impracticable for other gravimetric methods because it is difficult to manipulate a larger sample through the individual steps of the analysis. With particulate gravimetry, however, the part of the sample that is not analyte is removed when filtering or extracting. Consequently, particulate gravimetry easily is extended to the analysis of trace-level analytes.

Except for methods that rely on a quartz crystal microbalance, particulate gravimetry uses the same balances as other gravimetric methods, and

¹¹ Muratsugu, M.; Ohta, F.; Miya, Y.; Hosokawa, T.; Kurosawa, S.; Kamo, N.; Ikeda, H. *Anal. Chem.* **1993**, *65*, 2933–2937.

is capable of achieving similar levels of accuracy and precision. Because particulate gravimetry is defined in terms of the mass of the particle themselves, the sensitivity of the analysis is given by the balance's sensitivity. Selectivity, on the other hand, is determined either by the filter's pore size or by the properties of the extracting phase. Because it requires a single step, particulate gravimetric methods based on filtration generally require less time, labor and capital than other gravimetric methods.

8E Key Terms

coagulation	conservation of mass	coprecipitate
definitive technique	digestion	direct analysis
electrogravimetry	gravimetry	homogeneous precipitation
ignition	inclusion	indirect analysis
occlusion	particulate gravimetry	peptization
precipitant	precipitation gravimetry	quartz crystal microbalance
relative supersaturation	reprecipitation	supernatant
surface adsorbate	thermogram	thermogravimetry
volatilization gravimetry		

8F Chapter Summary

In a gravimetric analysis, a measurement of mass or a change in mass provides quantitative information about the analyte. The most common form of gravimetry uses a precipitation reaction to generate a product whose mass is proportional to the amount of analyte. In many cases the precipitate includes the analyte; however, an indirect analysis in which the analyte causes the precipitation of another compound also is possible. Precipitation gravimetric procedures must be carefully controlled to produce precipitates that are easy to filter, free from impurities, and of known stoichiometry.

In volatilization gravimetry, thermal or chemical energy decomposes the sample containing the analyte. The mass of residue that remains after decomposition, the mass of volatile products collected using a suitable trap, or a change in mass due to the loss of volatile material are all gravimetric measurements.

When the analyte is already present in a particulate form that is easy to separate from its matrix, then a particulate gravimetric analysis is feasible. Examples include the determination of dissolved solids and the determination of fat in foods.

8G Problems

1. Starting with the equilibrium constant expressions for [reaction 8.1](#), and for [reactions 8.3–8.5](#), verify that [equation 8.7](#) is correct.

2. [Equation 8.7](#) explains how the solubility of AgCl varies as a function of the equilibrium concentration of Cl^- . Derive a similar equation that describes the solubility of AgCl as a function of the equilibrium concentration of Ag^+ . Graph the resulting solubility function and compare it to that shown in [Figure 8.1](#).
3. Construct a solubility diagram for $\text{Zn}(\text{OH})_2$ that takes into account the following soluble zinc-hydroxide complexes: $\text{Zn}(\text{OH})^+$, $\text{Zn}(\text{OH})_3^-$, and $\text{Zn}(\text{OH})_4^{2-}$. What is the optimum pH for the quantitative precipitation of $\text{Zn}(\text{OH})_2$? For your solubility diagram, plot $\log(S)$ on the y -axis and pH on the x -axis. See the appendices for relevant equilibrium constants.
4. Starting with [equation 8.10](#), verify that [equation 8.11](#) is correct.
5. For each of the following precipitates, use a ladder diagram to identify the pH range where the precipitates has its lowest solubility? See the appendices for relevant equilibrium constants.
 - a. CaC_2O_4
 - b. PbCrO_4
 - c. BaSO_4
 - d. SrCO_3
 - e. ZnS
6. Mixing solutions of 1.5 M KNO_3 and 1.5 M HClO_4 produces a precipitate of KClO_4 . If permanganate ions are present, an inclusion of KMnO_4 is possible. Shown below are descriptions of two experiments in which KClO_4 is precipitated in the presence of MnO_4^- . Explain why the experiments lead to the different results shown in [Figure 8.15](#).

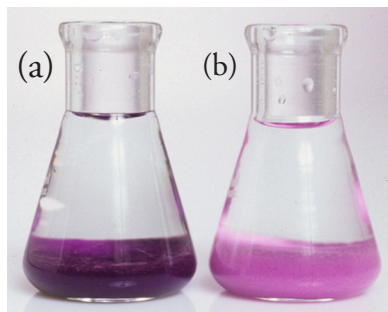

Figure 8.15 Results for the experiments in Problem 8.6. (a) Experiment 1; (b) Experiment 2.

Experiment 1. Place 1 mL of 1.5 M KNO_3 in a test tube, add 3 drops of 0.1 M KMnO_4 , and swirl to mix. Add 1 mL of 1.5 M HClO_4 dropwise, agitating the solution between drops. Destroy the excess KMnO_4 by adding 0.1 M NaHSO_3 dropwise. The resulting precipitate of KClO_4 has an intense purple color.

Experiment 2. Place 1 mL of 1.5 M HClO_4 in a test tube, add 3 drops of 0.1 M KMnO_4 , and swirl to mix. Add 1 mL of 1.5 M KNO_3 dropwise, agitating the solution between drops. Destroy the excess KMnO_4 by adding 0.1 M NaHSO_3 dropwise. The resulting precipitate of KClO_4 has a pale purple in color.

7. Mixing solutions of $\text{Ba}(\text{SCN})_2$ and MgSO_4 produces a precipitate of BaSO_4 . Shown below are the descriptions and results for three experiments using different concentrations of $\text{Ba}(\text{SCN})_2$ and MgSO_4 . Explain why these experiments produce different results.

Experiment 1. When equal volumes of 3.5 M $\text{Ba}(\text{SCN})_2$ and 3.5 M MgSO_4 are mixed, a gelatinous precipitate forms immediately.

Experiment 2. When equal volumes of 1.5 M $\text{Ba}(\text{SCN})_2$ and 1.5 M MgSO_4 are mixed, a curdy precipitate forms immediately. Individual particles of BaSO_4 are seen as points under a magnification of $1500\times$ (a particle size less than $0.2\ \mu\text{m}$).

Experiment 3. When equal volumes of 0.5 mM $\text{Ba}(\text{SCN})_2$ and 0.5 mM MgSO_4 are mixed, the complete precipitation of BaSO_4 requires 2–3 h. Individual crystals of BaSO_4 obtain lengths of approximately $5\ \mu\text{m}$.

8. Aluminum is determined gravimetrically by precipitating $\text{Al}(\text{OH})_3$ and isolating Al_2O_3 . A sample that contains approximately 0.1 g of Al is dissolved in 200 mL of H_2O , and 5 g of NH_4Cl and a few drops of methyl red indicator are added (methyl red is red at pH levels below 4 and yellow at pH levels above 6). The solution is heated to boiling and 1:1 NH_3 is added dropwise until the indicator turns yellow, precipitating $\text{Al}(\text{OH})_3$. The precipitate is held at the solution's boiling point for several minutes before filtering and rinsing with a hot solution of 2% w/v NH_4NO_3 . The precipitate is then ignited at $1000\text{--}1100^\circ\text{C}$, forming Al_2O_3 .
 - (a) Cite at least two ways in which this procedure encourages the formation of larger particles of precipitate.
 - (b) The ignition step is carried out carefully to ensure the quantitative conversion of $\text{Al}(\text{OH})_3$ to Al_2O_3 . What is the effect of an incomplete conversion on the %w/w Al?
 - (c) What is the purpose of adding NH_4Cl and methyl red indicator?
 - (d) An alternative procedure for aluminum involves isolating and weighing the precipitate as the 8-hydroxyquinolate, $\text{Al}(\text{C}_9\text{H}_6\text{NO})_3$. Why might this be a more advantageous form of Al for a gravimetric analysis? Are there any disadvantages?

9. Calcium is determined gravimetrically by precipitating $\text{CaC}_2\text{O}_4\cdot\text{H}_2\text{O}$ and isolating CaCO_3 . After dissolving a sample in 10 mL of water and 15 mL of 6 M HCl, the resulting solution is heated to boiling and a warm solution of excess ammonium oxalate is added. The solution is maintained at 80°C and 6 M NH_3 is added dropwise, with stirring, until the solution is faintly alkaline. The resulting precipitate and solution are removed from the heat and allowed to stand for at least one hour. After testing the solution for completeness of precipitation, the sample is filtered, rinsed with 0.1% w/v ammonium oxalate, and dried for one hour at $100\text{--}120^\circ\text{C}$. The precipitate is transferred to a muffle

furnace where it is converted to CaCO_3 by drying at $500 \pm 25^\circ\text{C}$ until constant weight.

- Why is the precipitate of $\text{CaC}_2\text{O}_4 \cdot \text{H}_2\text{O}$ converted to CaCO_3 ?
- In the final step, if the sample is heated at too high of a temperature some CaCO_3 is converted to CaO . What effect would this have on the reported %w/w Ca?
- Why is the precipitant, $(\text{NH}_4)_2\text{C}_2\text{O}_4$, added to a hot, acidic solution instead of a cold, alkaline solution?

10. Iron is determined gravimetrically by precipitating as $\text{Fe}(\text{OH})_3$ and igniting to Fe_2O_3 . After dissolving a sample in 50 mL of H_2O and 10 mL of 6 M HCl , any Fe^{2+} is converted Fe^{3+} by oxidizing with 1–2 mL of concentrated HNO_3 . The sample is heated to remove the oxides of nitrogen and the solution is diluted to 200 mL. After bringing the solution to a boil, $\text{Fe}(\text{OH})_3$ is precipitated by slowly adding 1:1 NH_3 until an odor of NH_3 is detected. The solution is boiled for an additional minute and the precipitate allowed to settle. The precipitate is then filtered and rinsed with several portions of hot 1% w/v NH_4NO_3 until no Cl^- is found in the wash water. Finally, the precipitate is ignited to constant weight at $500\text{--}550^\circ\text{C}$ and weighed as Fe_2O_3 .

- If ignition is not carried out under oxidizing conditions (plenty of O_2 present), the final product may contain Fe_3O_4 . What effect will this have on the reported %w/w Fe?
- The precipitate is washed with a dilute solution of NH_4NO_3 . Why is NH_4NO_3 added to the wash water?
- Why does the procedure call for adding NH_3 until the odor of ammonia is detected?
- Describe how you might test the filtrate for Cl^- .

11. Sinha and Shome described a gravimetric method for molybdenum in which it is precipitated as $\text{MoO}_2(\text{C}_{13}\text{H}_{10}\text{NO}_2)_2$ using *n*-benzoylphenylhydroxylamine, $\text{C}_{13}\text{H}_{11}\text{NO}_2$, as the precipitant.¹² The precipitate is weighed after igniting to MoO_3 . As part of their study, the authors determined the optimum conditions for the analysis. Samples that contained 0.0770 g of Mo each were taken through the procedure while varying the temperature, the amount of precipitant added, and the pH of the solution. The solution volume was held constant at 300 mL for all experiments. A summary of their results is shown in the following table.

¹² Sinha, S. K.; Shome, S. C. *Anal. Chim. Acta* **1960**, *24*, 33–36.

Temperature (°C)	Mass (g) of precipitant	Volume (mL) of 10 M HCl	Mass (g) of MoO ₃
30	0.20	0.9	0.0675
30	0.30	0.9	0.1014
30	0.35	0.9	0.1140
30	0.42	0.9	0.1155
30	0.42	0.3	0.1150
30	0.42	18.0	0.1152
30	0.42	48.0	0.1160
30	0.42	75.0	0.1159
50	0.42	0.9	0.1156
75	0.42	0.9	0.1158
80	0.42	0.9	0.1129

Based on these results, discuss the optimum conditions for determining Mo by this method. Express your results for the precipitant as the minimum %w/v in excess, needed to ensure a quantitative precipitation.

- A sample of an impure iron ore is approximately 55% w/w Fe. If the amount of Fe in the sample is determined gravimetrically by isolating it as Fe₂O₃, what mass of sample is needed to ensure that we isolate at least 1.0 g of Fe₂O₃?
- The concentration of arsenic in an insecticide is determined gravimetrically by precipitating it as MgNH₄AsO₄ and isolating it as Mg₂As₂O₇. Determine the %w/w As₂O₃ in a 1.627-g sample of insecticide if it yields 106.5 mg of Mg₂As₂O₇.
- After preparing a sample of alum, K₂SO₄•Al₂(SO₄)₃•24H₂O, an analyst determines its purity by dissolving a 1.2931-g sample and precipitating the aluminum as Al(OH)₃. After filtering, rinsing, and igniting, 0.1357 g of Al₂O₃ is obtained. What is the purity of the alum preparation?
- To determine the amount of iron in a dietary supplement, a random sample of 15 tablets with a total weight of 20.505 g is ground into a fine powder. A 3.116-g sample is dissolved and treated to precipitate the iron as Fe(OH)₃. The precipitate is collected, rinsed, and ignited to a constant weight as Fe₂O₃, yielding 0.355 g. Report the iron content of the dietary supplement as g FeSO₄•7H₂O per tablet.
- A 1.4639-g sample of limestone is analyzed for Fe, Ca, and Mg. The iron is determined as Fe₂O₃ yielding 0.0357 g. Calcium is isolated as CaSO₄, yielding a precipitate of 1.4058 g, and Mg is isolated as

0.0672 g of $\text{Mg}_2\text{P}_2\text{O}_7$. Report the amount of Fe, Ca, and Mg in the limestone sample as %w/w Fe_2O_3 , %w/w CaO, and %w/w MgO.

17. The number of ethoxy groups ($\text{CH}_3\text{CH}_2\text{O}-$) in an organic compound is determined by the following two reactions.

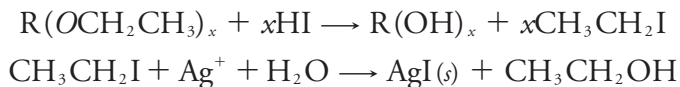

A 36.92-mg sample of an organic compound with an approximate molecular weight of 176 is treated in this fashion, yielding 0.1478 g of AgI. How many ethoxy groups are there in each molecule of the compound?

18. A 516.7-mg sample that contains a mixture of K_2SO_4 and $(\text{NH}_4)_2\text{SO}_4$ is dissolved in water and treated with BaCl_2 , precipitating the SO_4^{2-} as BaSO_4 . The resulting precipitate is isolated by filtration, rinsed free of impurities, and dried to a constant weight, yielding 863.5 mg of BaSO_4 . What is the %w/w K_2SO_4 in the sample?
19. The amount of iron and manganese in an alloy is determined by precipitating the metals with 8-hydroxyquinoline, $\text{C}_9\text{H}_7\text{NO}$. After weighing the mixed precipitate, the precipitate is dissolved and the amount of 8-hydroxyquinoline determined by another method. In a typical analysis a 127.3-mg sample of an alloy containing iron, manganese, and other metals is dissolved in acid and treated with appropriate masking agents to prevent an interference from other metals. The iron and manganese are precipitated and isolated as $\text{Fe}(\text{C}_9\text{H}_6\text{NO})_3$ and $\text{Mn}(\text{C}_9\text{H}_6\text{NO})_2$, yielding a total mass of 867.8 mg. The amount of 8-hydroxyquinolate in the mixed precipitate is determined to be 5.276 mmol. Calculate the %w/w Fe and %w/w Mn in the alloy.
20. A 0.8612-g sample of a mixture of NaBr, NaI, and NaNO_3 is analyzed by adding AgNO_3 and precipitating a 1.0186-g mixture of AgBr and AgI. The precipitate is then heated in a stream of Cl_2 , which converts it to 0.7125 g of AgCl. Calculate the %w/w NaNO_3 in the sample.
20. The earliest determinations of elemental atomic weights were accomplished gravimetrically. To determine the atomic weight of manganese, a carefully purified sample of MnBr_2 weighing 7.16539 g is dissolved and the Br^- precipitated as AgBr, yielding 12.53112 g. What is the atomic weight for Mn if the atomic weights for Ag and Br are taken to be 107.868 and 79.904, respectively?
22. While working as a laboratory assistant you prepared 0.4 M solutions of AgNO_3 , $\text{Pb}(\text{NO}_3)_2$, BaCl_2 , KI and Na_2SO_4 . Unfortunately, you became distracted and forgot to label the solutions before leaving the

laboratory. Realizing your error, you label the solutions A–E and perform all possible binary mixtures of the five solutions, obtaining the results shown in Figure 8.16 (key: NP means no precipitate formed, W means a white precipitate formed, and Y means a yellow precipitate formed). Identify solutions A–E.

23. A solid sample has approximately equal amounts of two or more of the following soluble salts: AgNO_3 , ZnCl_2 , K_2CO_3 , MgSO_4 , $\text{Ba}(\text{C}_2\text{H}_3\text{O}_2)_2$, and NH_4NO_3 . A sample of the solid, sufficient to give at least 0.04 moles of any single salt, is added to 100 mL of water, yielding a white precipitate and a clear solution. The precipitate is collected and rinsed with water. When a portion of the precipitate is placed in dilute HNO_3 it completely dissolves, leaving a colorless solution. A second portion of the precipitate is placed in dilute HCl , yielding a solid and a clear solution; when its filtrate is treated with excess NH_3 , a white precipitate forms. Identify the salts that must be present in the sample, the salts that must be absent, and the salts for which there is insufficient information to make this determination.¹³
24. Two methods have been proposed for the analysis of pyrite, FeS_2 , in impure samples of the ore. In the first method, the sulfur in FeS_2 is determined by oxidizing it to SO_4^{2-} and precipitating it as BaSO_4 . In the second method, the iron in FeS_2 is determined by precipitating the iron as $\text{Fe}(\text{OH})_3$ and isolating it as Fe_2O_3 . Which of these methods provides the more sensitive determination for pyrite? What other factors should you consider in choosing between these methods?
25. A sample of impure pyrite that is approximately 90–95% w/w FeS_2 is analyzed by oxidizing the sulfur to SO_4^{2-} and precipitating it as BaSO_4 . How many grams of the sample should you take to ensure that you obtain at least 1.0 g of BaSO_4 ?
26. A series of samples that contain any possible combination of KCl , NaCl , and NH_4Cl is to be analyzed by adding AgNO_3 and precipitating AgCl . What is the minimum volume of 5% w/v AgNO_3 necessary to precipitate completely the chloride in any 0.5-g sample?
27. If a precipitate of known stoichiometry does not form, a gravimetric analysis is still feasible if we can establish experimentally the mole ratio between the analyte and the precipitate. Consider, for example, the precipitation gravimetric analysis of Pb as PbCrO_4 .¹⁴
- (a) For each gram of Pb , how many grams of PbCrO_4 will form, assuming the reaction is stoichiometric?

	A	B	C	D	E
A		NP	Y	NP	W
B			Y	W	W
C				NP	NP
D					W

Figure 8.16 Results of the binary mixing of solutions A–E for Problem 8.22.

¹³ Adapted from Sorum, C. H.; Lagowski, J. J. *Introduction to Semimicro Qualitative Analysis*, Prentice-Hall: Englewood Cliffs, N. J., 5th Ed., 1977, p. 285.

¹⁴ Grote, F. Z. *Anal. Chem.* **1941**, *122*, 395–398.

- (b) In a study of this procedure, Grote found that 1.568 g of PbCrO_4 formed for each gram of Pb. What is the apparent stoichiometry between Pb and PbCrO_4 ?
- (c) Does failing to account for the actual stoichiometry lead to a positive determinate error or a negative determinate error?
28. Determine the uncertainty for the gravimetric analysis described in [Example 8.1](#). The expected accuracy for a gravimetric method is 0.1–0.2%. What additional sources of error might account for the difference between your estimated uncertainty and the expected accuracy?
29. A 38.63-mg sample of potassium ozonide, KO_3 , is heated to 70°C for 1 h, undergoing a weight loss of 7.10 mg. A 29.6-mg sample of impure KO_3 experiences a 4.86-mg weight loss when treated under similar condition. What is the %w/w KO_3 in the sample?
30. The water content of an 875.4-mg sample of cheese is determined with a moisture analyzer. What is the %w/w H_2O in the cheese if the final mass was found to be 545.8 mg?
31. [Representative Method 8.2](#) describes a procedure for determining Si in ores and alloys. In this analysis a weight loss of 0.21 g corresponds to 0.1 g of Si. Show that this relationship is correct.
32. The iron in an organometallic compound is determined by treating a 0.4873-g sample with HNO_3 and heating to volatilize the organic material. After ignition, the residue of Fe_2O_3 weighs 0.2091 g.
- (a) What is the %w/w Fe in this compound?
- (b) The carbon and hydrogen in a second sample of the compound are determined by a combustion analysis. When a 0.5123-g sample is carried through the analysis, 1.2119 g of CO_2 and 0.2482 g of H_2O are collected. What are the %w/w C and %w/w H in this compound and what is the compound's empirical formula?
33. A polymer's ash content is determined by placing a weighed sample in a Pt crucible previously brought to a constant weight. The polymer is melted using a Bunsen burner until the volatile vapor ignites and then allowed to burn until a non-combustible residue remain. The residue then is brought to constant weight at 800°C in a muffle furnace. The following data were collected for two samples of a polymer resin.

Polymer A	g crucible	g crucible + polymer	g crucible + ash
replicate 1	19.1458	21.2287	19.7717
replicate 2	15.9193	17.9522	16.5310
replicate 3	15.6992	17.6660	16.2909

Polymer B	g crucible	g crucible + polymer	g crucible + ash
replicate 1	19.1457	21.0693	19.7187
replicate 2	15.6991	17.8273	16.3327
replicate 3	15.9196	17.9037	16.5110

- (a) For each polymer, determine the mean and the standard deviation for the %w/w ash.
- (b) Is there any evidence at $\alpha = 0.05$ for a significant difference between the two polymers? See the appendices for statistical tables.
34. In the presence of water vapor the surface of zirconia, ZrO_2 , chemically adsorbs H_2O , forming surface hydroxyls, $ZrOH$ (additional water is physically adsorbed as H_2O). When heated above $200^\circ C$, the surface hydroxyls convert to $H_2O(g)$, releasing one molecule of water for every two surface hydroxyls. Below $200^\circ C$ only physically absorbed water is lost. Nawrocki, et al. used thermogravimetry to determine the density of surface hydroxyls on a sample of zirconia that was heated to $700^\circ C$ and cooled in a desiccator containing humid N_2 .¹⁵ Heating the sample from $200^\circ C$ to $900^\circ C$ released 0.006 g of H_2O for every gram of dehydroxylated ZrO_2 . Given that the zirconia had a surface area of 33 m^2/g and that one molecule of H_2O forms two surface hydroxyls, calculate the density of surface hydroxyls in $\mu mol/m^2$.
35. The concentration of airborne particulates in an industrial workplace is determined by pulling the air for 20 min through a single-stage air sampler equipped with a glass-fiber filter at a rate of 75 m^3/h . At the end of the sampling period, the filter's mass is found to have increased by 345.2 mg. What is the concentration of particulates in the air sample in mg/m^3 and mg/L ?
36. The fat content of potato chips is determined indirectly by weighing a sample before and after extracting the fat with supercritical CO_2 . The following data were obtained for the analysis of potato chips.¹⁶

Sample Number	Initial Mass (g)	Final Mass (g)
1	1.1661	0.9253
2	1.1723	0.9252
3	1.2525	0.9850
4	1.2280	0.9562
5	1.2837	1.0119

- (a) Determine the mean and standard deviation for the %w/w fat.

¹⁵ Nawrocki, J.; Carr, P. W.; Annen, M. J.; Froelicher, S. *Anal. Chim. Acta* **1996**, *327*, 261–266.

¹⁶ *Fat Determination by SFE*, ISCO, Inc. Lincoln, NE.

- (b) This sample of potato chips is known to have a fat content of 22.7% w/w. Is there any evidence for a determinate error at $\alpha=0.05$? See the appendices for statistical tables.

37. Delumyea and McCleary reported results for the %w/w organic material in sediment samples collected at different depths from a cove on the St. Johns River in Jacksonville, FL.¹⁷ After collecting a sediment core, they sectioned it into 2-cm increments. Each increment was treated using the following procedure:

- the sediment was placed in 50 mL of deionized water and the resulting slurry filtered through preweighed filter paper;
- the filter paper and the sediment were placed in a preweighed evaporating dish and dried to a constant weight in an oven at 110 °C;
- the evaporating dish with the filter paper and the sediment were transferred to a muffle furnace where the filter paper and any organic material in the sample were removed by ashing;
- finally, the inorganic residue remaining after ashing was weighed.

Using the following data, determine the %w/w organic matter as a function of the average depth for each increment. Prepare a plot showing how the %w/w organic matter varies with depth and comment on your results.

Depth (cm)	Mass (g) of...		Mass (g) of Filter Paper, Dish, and Sediment...	
	Filter Paper	Dish	After Drying	After Ashing
0–2	1.590	43.21	52.10	49.49
2–4	1.745	40.62	48.83	46.00
4–6	1.619	41.23	52.86	47.84
6–8	1.611	42.10	50.59	47.13
8–10	1.658	43.62	51.88	47.53
10–12	1.628	43.24	49.45	45.31
12–14	1.633	43.08	47.92	44.20
14–16	1.630	43.96	58.31	55.53
16–18	1.636	43.36	54.37	52.75

38. Yao, et al. described a method for the quantitative analysis of thiourea based on its reaction with I_2 .¹⁸

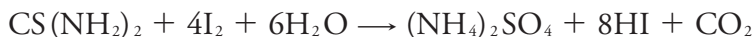

¹⁷ Delumyea, R. D.; McCleary, D. L. *J. Chem. Educ.* **1993**, *70*, 172–173.

¹⁸ Yao, S. F.; He, F. J.; Nie, L. H. *Anal. Chim. Acta* **1992**, *268*, 311–314.

The procedure calls for placing a 100- μL aqueous sample that contains thiourea in a 60-mL separatory funnel and adding 10 mL of a pH 7 buffer and 10 mL of 12 μM I_2 in CCl_4 . The contents of the separatory funnel are shaken and the organic and aqueous layers allowed to separate. The organic layer, which contains the excess I_2 , is transferred to the surface of a piezoelectric crystal on which a thin layer of Au has been deposited. After allowing the I_2 to adsorb to the Au, the CCl_4 is removed and the crystal's frequency shift, Δf , measured. The following data is reported for a series of thiourea standards.

[thiourea] (M)	Δf (Hz)	[thiourea] (M)	Δf (Hz)
3.00×10^{-7}	74.6	1.50×10^{-6}	327
5.00×10^{-7}	120	2.50×10^{-6}	543
7.00×10^{-7}	159	3.50×10^{-6}	789
9.00×10^{-7}	205	5.00×10^{-6}	1089

- Characterize this method with respect to the scale of operation shown in [Figure 3.5](#) of Chapter 3.
- Prepare a calibration curve and use a regression analysis to determine the relationship between the crystal's frequency shift and the concentration of thiourea.
- If a sample that contains an unknown amount of thiourea gives a Δf of 176 Hz, what is the molar concentration of thiourea in the sample?
- What is the 95% confidence interval for the concentration of thiourea in this sample assuming one replicate? See the appendices for statistical tables.

8H Solutions to Practice Exercises

Practice Exercise 8.1

The solubility reaction for CaC_2O_4 is

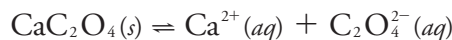

To minimize solubility, the pH must be sufficiently basic that oxalate, $\text{C}_2\text{O}_4^{2-}$, does not react to form HC_2O_4^- or $\text{H}_2\text{C}_2\text{O}_4$. The ladder diagram for oxalic acid, including approximate buffer ranges, is shown in Figure 8.17. Maintaining a pH greater than 5.3 ensures that $\text{C}_2\text{O}_4^{2-}$ is the only important form of oxalic acid in solution, minimizing the solubility of CaC_2O_4 .

Click [here](#) to return to the chapter.

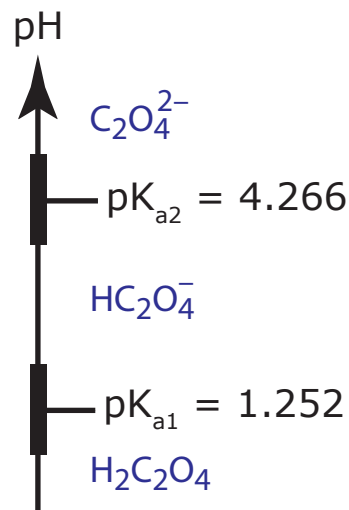

Figure 8.17 pH ladder diagram for oxalic acid, $\text{H}_2\text{C}_2\text{O}_4$.

Practice Exercise 8.2

A conservation of mass requires that all zinc in the alloy is found in the final product, $\text{Zn}_2\text{P}_2\text{O}_7$. We know there are 2 moles of Zn per mole of $\text{Zn}_2\text{P}_2\text{O}_7$; thus

$$0.1163 \text{ g Zn}_2\text{P}_2\text{O}_7 \times \frac{2 \text{ mol Zn}}{304.70 \text{ g Zn}_2\text{P}_2\text{O}_7} \times \frac{65.38 \text{ g Zn}}{\text{mol Zn}} = 0.04991 \text{ g Zn}$$

This is the mass of Zn in 25% of the sample (a 25.00 mL portion of the 100.0 mL total volume). The %w/w Zn, therefore, is

$$\frac{0.04991 \text{ g Zn} \times 4}{0.7336 \text{ g sample}} \times 100 = 27.21\% \text{ w/w Zn}$$

For copper, we find that

$$0.2383 \text{ g CuSCN} \times \frac{1 \text{ mol Zn}}{121.63 \text{ g CuSCN}} \times \frac{63.55 \text{ g Cu}}{\text{mol Cu}} = 0.1245 \text{ g Cu}$$

$$\frac{0.1245 \text{ g Cu} \times 4}{0.7336 \text{ g sample}} \times 100 = 67.88\% \text{ w/w Cu}$$

Click [here](#) to return to the chapter.

Practice Exercise 8.3

The masses of the solids provide us with the following equations

$$\text{g NaCl} + \text{g KCl} = 0.2692 \text{ g}$$

$$(\text{g KClO}_4)_{\text{NaCl}} + (\text{g KClO}_4)_{\text{KCl}} = 0.5713 \text{ g}$$

where $(\text{g KClO}_4)_{\text{NaCl}}$ and $(\text{g KClO}_4)_{\text{KCl}}$ are the masses of KClO_4 from the reaction of HClO_4 with NaCl and KCl. With two equations and four unknowns, we need two additional equations to solve the problem. A conservation of mass requires that all the chlorine in NaCl is found in the $(\text{KClO}_4)_{\text{NaCl}}$; thus

$$(\text{g KClO}_4)_{\text{NaCl}} = \text{g NaCl} \times \frac{1 \text{ mol Cl}}{58.44 \text{ g NaCl}} \times \frac{138.55 \text{ g KClO}_4}{\text{mol Cl}}$$

$$(\text{g KClO}_4)_{\text{NaCl}} = 2.3708 \times \text{g NaCl}$$

Using the same approach for KCl gives

$$(\text{g KClO}_4)_{\text{KCl}} = \text{g KCl} \times \frac{1 \text{ mol Cl}}{74.55 \text{ g KCl}} \times \frac{138.55 \text{ g KClO}_4}{\text{mol Cl}}$$

$$(\text{g KClO}_4)_{\text{KCl}} = 1.8585 \times \text{g KCl}$$

Substituting the equations for $(\text{g KClO}_4)_{\text{NaCl}}$ and $(\text{g KClO}_4)_{\text{KCl}}$ into the equation for their combined masses leaves us with two equations and two unknowns.

$$\text{g NaCl} + \text{g KCl} = 0.2692 \text{ g}$$

$$2.3708 \times \text{g NaCl} + 1.8585 \times \text{g KCl} = 0.5713 \text{ g}$$

Multiplying the first equation by 1.8585 and subtracting the second equation gives

$$-0.5123 \times \text{g NaCl} = -0.7099 \text{ g}$$

$$\text{g NaCl} = 0.1386 \text{ g}$$

To report the %w/w Na_2O in the sample, we use a conservation of mass on sodium.

$$0.1386 \text{ g NaCl} \times \frac{1 \text{ mol Na}}{58.44 \text{ g NaCl}} \times \frac{61.98 \text{ g Na}_2\text{O}}{2 \text{ mol Na}} = 0.07350 \text{ g Na}_2\text{O}$$

$$\frac{0.07350 \text{ g Na}_2\text{O}}{0.8143 \text{ g sample}} \times 100 = 9.026\% \text{ w/w Na}_2\text{O}$$

Click [here](#) to return to the chapter.

Practice Exercise 8.4

To find the mass of $(\text{NH}_4)_3\text{PO}_4 \cdot 12\text{MoO}_3$ that will produce 0.600 g of PbMoO_3 , we first use a conservation of mass for molybdenum; thus

$$0.600 \text{ g PbMoO}_3 \times \frac{1 \text{ mol Mo}}{351.2 \text{ g PbMoO}_3} \times \frac{1876.59 \text{ g } (\text{NH}_4)_3\text{PO}_4 \cdot 12\text{MoO}_3}{12 \text{ mol Mo}} = 0.2672 \text{ g } (\text{NH}_4)_3\text{PO}_4 \cdot 12\text{MoO}_3$$

Next, to convert this mass of $(\text{NH}_4)_3\text{PO}_4 \cdot 12\text{MoO}_3$ to a mass of Na_3PO_4 , we use a conservation of mass on PO_4^{3-} .

$$0.2672 \text{ g } (\text{NH}_4)_3\text{PO}_4 \cdot 12\text{MoO}_3 \times \frac{1 \text{ mol PO}_4^{3-}}{1876.59 \text{ g } (\text{NH}_4)_3\text{PO}_4 \cdot 12\text{MoO}_3} \times \frac{163.94 \text{ g Na}_3\text{PO}_4}{\text{mol PO}_4^{3-}} = 0.02334 \text{ g Na}_3\text{PO}_4$$

Finally, we convert this mass of Na_3PO_4 to the corresponding mass of sample.

$$0.02334 \text{ g Na}_3\text{PO}_4 \times \frac{100 \text{ g sample}}{12.5 \text{ g Na}_3\text{PO}_4} = 0.187 \text{ g sample}$$

A sample of 0.187 g is sufficient to guarantee that we recover a minimum of 0.600 g PbMoO_3 . If a sample contains more than 12.5% Na_3PO_4 , then a 0.187-g sample will produce more than 0.600 g of PbMoO_3 .

Click [here](#) to return to the chapter.

Practice Exercise 8.5

To determine which form has the greatest sensitivity, we use a conservation of mass for iron to find the relationship between the precipitate's mass and the mass of iron.

$$\begin{aligned} \text{g FeO} &= \text{g Fe} \times \frac{1 \text{ mol Fe}}{55.85 \text{ g Fe}} \times \frac{71.84 \text{ g FeO}}{\text{mol Fe}} = 1.286 \times \text{g Fe} \\ \text{g Fe}_2\text{O}_3 &= \text{g Fe} \times \frac{1 \text{ mol Fe}}{55.85 \text{ g Fe}} \times \frac{159.69 \text{ g Fe}_2\text{O}_3}{2 \text{ mol Fe}} = 1.430 \times \text{g Fe} \\ \text{g Fe}_3\text{O}_4 &= \text{g Fe} \times \frac{1 \text{ mol Fe}}{55.85 \text{ g Fe}} \times \frac{231.53 \text{ g Fe}_3\text{O}_4}{3 \text{ mol Fe}} = 1.382 \times \text{g Fe} \end{aligned}$$

Of the three choices, the greatest sensitivity is obtained with Fe_2O_3 because it provides the largest value for k .

Click [here](#) to return to the chapter.

Practice Exercise 8.6

From 100–250 °C the sample loses 13.8% of its mass, or a loss of

$$0.138 \times 130.34 \text{ g/mol} = 18.0 \text{ g/mol}$$

which is consistent with the loss of $\text{H}_2\text{O}(g)$ and a residue of MgC_2O_4 . From 350–550 °C the sample loses 55.23% of its original mass, or a loss of

$$0.5523 \times 130.34 \text{ g/mol} = 71.99 \text{ g/mol}$$

This weight loss is consistent with the simultaneous loss of $\text{CO}(g)$ and $\text{CO}_2(g)$, leaving a residue of MgO .

We can analyze the mixture by heating a portion of the sample to 300 °C, 600 °C, and 1000 °C, recording the mass at each temperature. The loss of mass between 600 °C and 1000 °C, Δm_2 , is due to the loss of $\text{CO}_2(g)$ from the decomposition of CaCO_3 to CaO , and is proportional to the mass of $\text{CaC}_2\text{O}_4 \cdot \text{H}_2\text{O}$ in the sample.

$$\text{g CaC}_2\text{O}_4 \cdot \text{H}_2\text{O} = \Delta m_2 \times \frac{1 \text{ mol CO}_2}{44.01 \text{ g CO}_2} \times \frac{146.11 \text{ g CaC}_2\text{O}_4 \cdot \text{H}_2\text{O}}{\text{mol CO}_2}$$

The change in mass between 300 °C and 600 °C, Δm_1 , is due to the loss of $\text{CO}(g)$ from $\text{CaC}_2\text{O}_4 \cdot \text{H}_2\text{O}$ and the loss of $\text{CO}(g)$ and $\text{CO}_2(g)$ from $\text{MgC}_2\text{O}_4 \cdot \text{H}_2\text{O}$. Because we already know the amount of $\text{CaC}_2\text{O}_4 \cdot \text{H}_2\text{O}$ in the sample, we can calculate its contribution to Δm_1 .

$$\begin{aligned} (\Delta m_1)_{\text{Ca}} &= \text{g CaC}_2\text{O}_4 \cdot \text{H}_2\text{O} = \Delta m_2 \times \\ &\quad \frac{1 \text{ mol CO}}{146.11 \text{ g CaC}_2\text{O}_4 \cdot \text{H}_2\text{O}} \times \frac{28.01 \text{ g CO}}{\text{mol CO}} \end{aligned}$$

The change in mass between 300 °C and 600 °C due to the decomposition of $\text{MgC}_2\text{O}_4 \cdot \text{H}_2\text{O}$

$$(m_1)_{\text{Mg}} = \Delta m_1 - (\Delta m_1)_{\text{Ca}}$$

provides the mass of $\text{MgC}_2\text{O}_4 \cdot \text{H}_2\text{O}$ in the sample.

$$\text{g MgC}_2\text{O}_4 \cdot \text{H}_2\text{O} = (\Delta m_i)_{\text{Mg}} \times \frac{1 \text{ mol (CO + CO}_2)}{130.35 \text{ g MgC}_2\text{O}_4 \cdot \text{H}_2\text{O}} \times \frac{78.02 \text{ g (CO + CO}_2)}{\text{mol (CO + CO}_2)}$$

Click [here](#) to return to the chapter.

Practice Exercise 8.7

In [Practice Exercise 8.6](#) we developed an [equation](#) for the mass of $\text{CaC}_2\text{O}_4 \cdot \text{H}_2\text{O}$ in a mixture of $\text{CaC}_2\text{O}_4 \cdot \text{H}_2\text{O}$, $\text{MgC}_2\text{O}_4 \cdot \text{H}_2\text{O}$, and inert materials. Adapting this equation to a sample that contains CaC_2O_4 , MgC_2O_4 , and inert materials is easy; thus

$$\text{g CaC}_2\text{O}_4 = (0.1794 \text{ g} - 0.1294 \text{ g}) \times \frac{1 \text{ mol CO}_2}{44.01 \text{ g CO}_2} \times \frac{128.10 \text{ g CaC}_2\text{O}_4}{\text{mol CO}_2} = 0.1455 \text{ g CaC}_2\text{O}_4$$

The %w/w CaC_2O_4 in the sample is

$$\frac{0.1455 \text{ g CaC}_2\text{O}_4}{0.3317 \text{ g sample}} \times 100 = 43.86\% \text{ w/w CaC}_2\text{O}_4$$

Click [here](#) to return to the chapter.
